

# Operating Instructions

**Acctiva Professional Flash**  
**UCN US / CN 充电器**

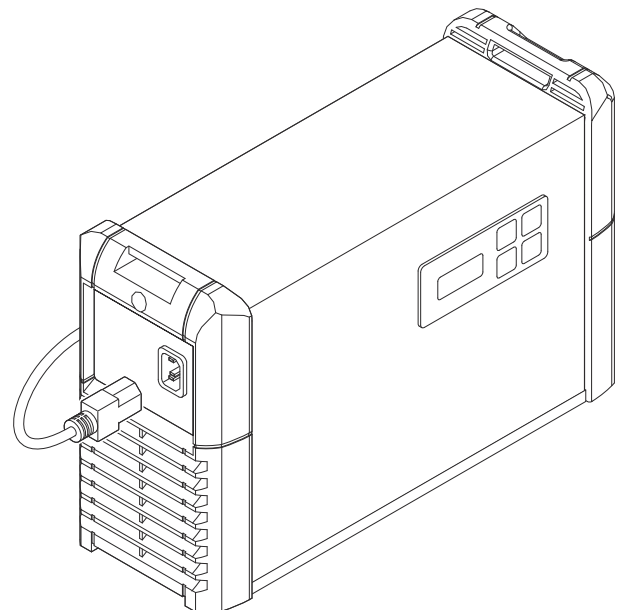

**EN** | Operating Instructions





# Safety rules

---

## Explanation of safety notices

### **DANGER!**

**Indicates immediate danger.**

- ▶ If not avoided, death or serious injury will result.
- 

### **WARNING!**

**Indicates a potentially hazardous situation.**

- ▶ If not avoided, death or serious injury may result.
- 

### **CAUTION!**

**Indicates a situation where damage or injury could occur.**

- ▶ If not avoided, minor injury and/or damage to property may result.
- 

### **NOTE!**

**Indicates a risk of flawed results and possible damage to the equipment.**

---

---

**General remarks**

The charger is manufactured in line with the latest state of the art and according to recognised safety standards. If used incorrectly or misused, however, it can cause

- injury or death to the user or a third party,
- damage to the charger and other material assets belonging to the operator,
- inefficient operation of the charger.

All persons involved in commissioning, operating, maintaining and servicing the charger must

- be suitably qualified,
- have knowledge of and experience in dealing with chargers and batteries and
- read and follow these operating instructions carefully.

The operating instructions must always be at hand wherever the charger is being used. In addition to the operating instructions, attention must also be paid to any generally applicable and local regulations regarding accident prevention and environmental protection.

All safety and danger notices on the charger

- must be kept in a legible state
- must not be damaged/marked
- must not be removed
- must not be covered, pasted or painted over..

For the location of the safety and danger notices on the charger, refer to „General remarks“ in the charger operating instructions. Before switching on the charger, remove any faults that could compromise safety.

**Your personal safety is at stake!**

---

**Intended use**

The device is to be used exclusively for its intended purpose. Any use above and beyond this purpose is deemed improper. The manufacturer is not liable for any damage, or unexpected or incorrect results arising out of such misuse.

---

Proper use also includes:

- Carefully reading and following all Operating Instructions, safety and danger notices
- Performing all stipulated inspection and servicing work
- Following all instructions from the battery and vehicle manufacturers

---

Proper handling of the device is essential for it to function correctly. Never pull on the cable when handling the device.

---

**Environmental conditions**

Operation or storage of the device outside the stipulated area will be deemed as not in accordance with the intended purpose. The manufacturer accepts no liability for any damage resulting from improper use.

---

**Mains connection**

Devices with a higher rating may affect the energy quality of the mains due to their current consumption.

---

This may affect a number of device types in terms of:

- Connection restrictions
- Criteria with regard to the maximum permissible mains impedance \*)
- Criteria with regard to the minimum short-circuit power requirement \*)

\*) at the interface with the public grid  
see "Technical data"

---

In this case, the plant operator or the person using the device should check whether the device may be connected, where appropriate by discussing the matter with the power supply company.

---

**IMPORTANT!** Ensure that the mains connection is earthed properly

---

### **Dangers from mains current and charging current**

Anyone working with battery chargers exposes themselves to numerous dangers, e.g.:

- Risk of electrocution from mains current and charging current.
  - Hazardous electromagnetic fields, which can risk the lives of those using cardiac pacemakers.
- 

An electric shock can be fatal. Every electric shock is potentially life threatening. To avoid electric shocks while using the charger:

- Do not touch any live parts inside or on the outside of the charger.
  - Under no circumstances touch the battery poles.
  - Do not short-circuit the charging cable or charging terminals.
- 

All cables and leads must be secured, undamaged, insulated and adequately dimensioned. Loose connections, scorched, damaged or inadequately dimensioned cables and leads must be immediately repaired by authorised personnel.

---

### **Danger due to acid, gases and vapours**

Batteries contain acid which is harmful to the eyes and skin. During charging, gases and vapours are released that may be harmful to health and are highly explosive in certain circumstances.

---

Only use the charger in well-ventilated areas to prevent the accumulation of explosive gases. Battery rooms are not deemed to be hazardous areas provided that a concentration of hydrogen of less than 4% can be guaranteed by the use of natural or forced ventilation.

---

Maintain a distance of at least 0.5 m (19.69 in.) between the battery and charger during the charging procedure. Possible sources of ignition such as fire and naked flames must be kept away from the battery.

---

The battery connection (e.g. charging terminals) must not be disconnected for any reason during charging.

---

Do not inhale any of the gases and vapours released under any circumstances -  
Make sure the area is well ventilated.

---

To prevent short circuits, do not place any tools or conductive metals on the battery.

---

Battery acid must not get into the eyes or onto the skin or clothes. Wear protective goggles and suitable protective clothing. Rinse any acid splashes thoroughly with clean water and seek medical advice if necessary.

---

---

**General information regarding the handling of batteries**

- Protect batteries from dirt and mechanical damage.
- Store charged batteries in a cool place. Self discharge is kept to a minimum at approx. +2 °C (35.6 °F).
- Carry out a visual inspection at least once a week or as often as specified by the battery manufacturer to ensure that the acid (electrolyte) level in the battery is at the max. mark.
- If any of the following occur, do not start the device (or stop immediately if already in use) and have the battery checked by an authorised workshop:
  - uneven acid levels and/or high water consumption in individual cells caused by a possible fault.
  - overheating of the battery above 55 °C (131 °F).

---

**Protecting yourself and others**

While the charger is in operation, keep all persons, especially children, out of the working area. If, however, there are people in the vicinity,

- warn them about all the dangers (hazardous acids and gases, danger from mains and charging current, etc.),
- provide suitable protective equipment.

Before leaving the work area, ensure that people or property cannot come to any harm in your absence.

---

**Operation by children and persons with limitations**

This device can be used by children aged 8 years and over, as well as individuals with reduced physical, sensory or mental capabilities, or a lack of experience and knowledge, if such persons are under supervision or have received instruction concerning use of the device in a safe way and if they understand the risks involved. Children must not play with the device. Children must not perform cleaning or user maintenance unless supervised.

---

**Safety measures in normal operation**

- Chargers with PE conductors must only be operated on a mains supply with a PE conductor and a socket with an earth contact. If the charger is operated on a mains supply without a PE conductor or in a socket without an earth contact, this will be deemed gross negligence. The manufacturer shall not be held liable for any damage arising from such usage.
- Only operate the charger in accordance with the degree of protection shown on the rating plate.
- Under no circumstances operate the charger if there is any evidence of damage.
- Ensure that the cooling air can enter and exit unhindered through the air ducts on the charger.
- Arrange for the mains and charger supply to be checked regularly by a qualified electrician to ensure the PE conductor is functioning properly.
- Any safety devices and parts that are not functioning properly or are in imperfect condition must be repaired by a qualified technician before switching on the charger.
- Never bypass or disable protection devices.
- After installation, a freely accessible mains plug is required.

---

**EMC Device Classifications**

Devices in emission class A:

- Are only designed for use in industrial settings
- Can cause line-bound and radiated interference in other areas

---

Devices in emission class B:

- Satisfy the emissions criteria for residential and industrial areas. This is also true for residential areas in which the energy is supplied from the public low-voltage mains.

---

EMC device classification as per the rating plate or technical data.

---

### **EMC measures**

In certain cases, even though a device complies with the standard limit values for emissions, it may affect the application area for which it was designed (e.g. when there is sensitive equipment at the same location, or if the site where the device is installed is close to either radio or television receivers).

If this is the case, then the operating company is obliged to take appropriate action to rectify the situation.

---

### **Data protection**

The user is responsible for the safekeeping of any changes made to the factory settings. The manufacturer accepts no liability for any deleted personal settings.

---

### **Maintenance and repair**

Under normal operating conditions, the device requires only a minimum of care and maintenance. However, it is vital to observe some important points to ensure it remains in a usable condition for many years.

- Before switching on, always check the mains plug and cable as well as charger leads and charging terminals for any signs of damage.
- If the surface of the device housing is dirty, clean with a soft cloth and solvent-free cleaning agent only

---

Maintenance and repair work must only be carried out by authorised personnel. Use only original replacement and wearing parts (also applies to standard parts). It is impossible to guarantee that bought-in parts are designed and manufactured to meet the demands made on them, or that they satisfy safety requirements.

---

Do not carry out any modifications, alterations, etc. to the device without the manufacturer's consent.

---

Dispose of in accordance with the applicable national and local regulations.

---

### **Warranty and liability**

The warranty period for the charger is 2 years from the date of invoice. However, the manufacturer will not accept any liability if the damage was caused by one or more of the following:

- Use of the charger "not in accordance with the intended purpose"
  - Improper installation and operation.
  - Operating the charger with faulty protection devices.
  - Non-compliance with the operating instructions.
  - Unauthorised modifications to the charger.
  - Catastrophes caused by the activities of third parties and force majeure.
- 

### **Safety inspection**

The manufacturer recommends that a safety inspection of the device is performed at least once every 12 months.

---

The safety inspection may only be performed by an appropriately qualified electrician

- After any changes have been made
- After any additional parts are installed, or after any conversions
- After repair, care and maintenance are carried out
- At least every twelve months

---

For safety inspections, follow the appropriate national and international standards and directives.

---

Further details on safety inspections can be obtained from your service centre. They will provide you on request with any documents you may require.

---

## **Disposal**

Waste electrical and electronic equipment must be collected separately and recycled in an environmentally-friendly way, in accordance with the European Directive and national legislation. Used equipment must be returned to the distributor or disposed of via an approved local collection and disposal facility. Correct disposal of used equipment promotes the sustainable recycling of material resources. Failing to dispose of used equipment correctly can lead to adverse health and/or environmental impacts.

### **Packaging materials**

Separate collection according to material. Check your local authority regulations. Crush containers to reduce size.

---

## **Markings on the device**

Devices with the CE marking satisfy the essential requirements of the applicable guidelines.

---

Devices displaying the EAC mark of conformity satisfy the requirements of the relevant standards in Russia, Belarus, Kazakhstan, Armenia and Kyrgyzstan.

---

## **Copyright**

Copyright of these operating instructions remains with the manufacturer.

---

The text and illustrations are all technically correct at the time of printing. We reserve the right to make changes. The contents of the operating instructions shall not provide the basis for any claims whatsoever on the part of the purchaser. If you have any suggestions for improvement, or can point out any mistakes that you have found in the instructions, we will be most grateful for your comments.



## Safety

### **WARNING!**

#### **Risk of injury and damage from exposed, rotating vehicle parts.**

When working in the vehicle's engine compartment, take care that hands, hair, items of clothing and charger leads do not come into contact with moving parts, e.g. fan belt, fan, etc.

### **CAUTION!**

#### **Setting the mode incorrectly can result in product damage and poor charging performance.**

Always set the mode according to the type of battery to be charged.

The charger is fitted with the following protection devices for safe handling:

- No sparks when clamping onto battery due to de-energised charging terminals
- Protection against short-circuiting of charging terminals/polarity reversal
- Protection against thermal overload of the charger

### **NOTE!**

#### **No protection from polarity reversal in the case of a deep-discharge battery.**

If the battery voltage is too low (< 1.0 V), the charger cannot detect whether the battery is connected or not. Before starting charging manually, check that the charging terminals are connected to the correct poles.

## Utilisation in accordance with "intended purpose"

The charger is intended exclusively for charging the following types of battery:

- Lead-acid batteries with liquid electrolyte (Pb, GEL, Ca, Ca silver) or
- Lead-acid batteries with fixed electrolyte (AGM, MF, sealant).

**IMPORTANT!** Charging dry batteries (primary cell) with this charger shall be deemed to be „not in accordance with the intended purpose“. The manufacturer shall not be liable for any damage resulting from such improper use.

## Symbols used

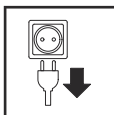

### **Devices equipped with main switch:**

- Switch off main device switch
- Unplug device from the mains

### **Devices with no main switch**

- Unplug device from the mains

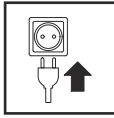

**Devices equipped with main switch:**

- Connect device to the mains
- Switch on device main switch

**Devices with no main switch:**

- Connect device to the mains

# Control elements and connections

## General remarks

### NOTE!

Owing to firmware updates, you may find that your machine has certain functions that are not described in these Operating Instructions, or vice-versa.

Also, certain illustrations may be slightly different from the actual controls on your machine. However, these controls function in exactly the same way.

## Controls and connections

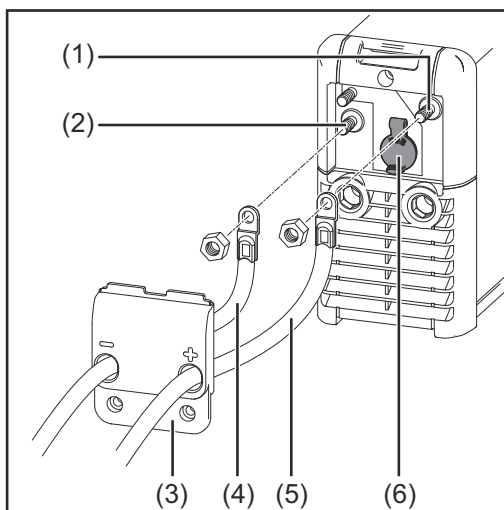

Front view

- (1) (+) charging terminal screw connection
- (2) (-) charging terminal screw connection
- (3) Cover for USB port
- (4) (-) charging terminal - black
- (5) (+) charging terminal - red
- (6) USB port  
For updating the firmware.

For further details please see our Internet homepage <http://www.fronius.com>

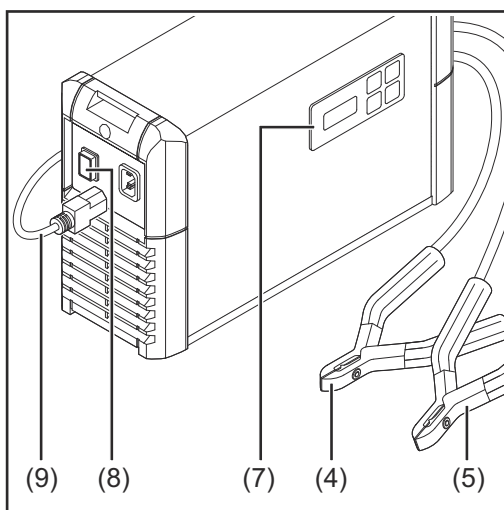

Rear view

- (7) Multifunction panel
- (8) Devices equipped with main switch
- (9) Mains cable/plug

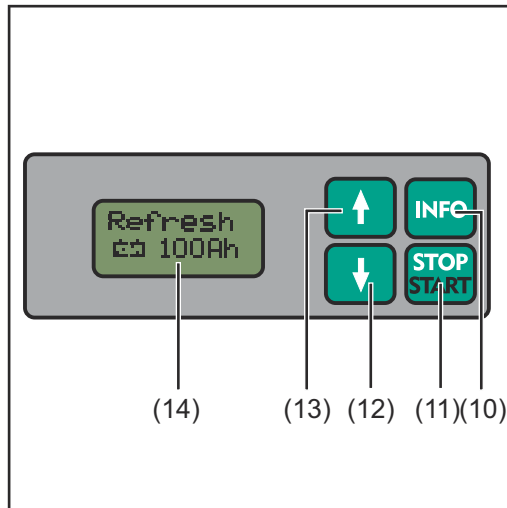

Multifunction panel

- (10) Info button  
For setting the desired mode  
for retrieving charging parameters during charging
- (11) Start/Stop button  
For interrupting and restarting charging
- (12) „Down“ button
- (13) „Up“ button
- (14) Display

# Fitting options

## Fitting optional edge guard

Depending on the device, a special edge guard can be fitted.

**IMPORTANT!** The edge guard must be fitted if the charger is being mounted on a wall, as the fitting tools assume that an edge guard is present. The edge guard must not be fitted if the charger is installed on the floor.

Fitting the edge guard

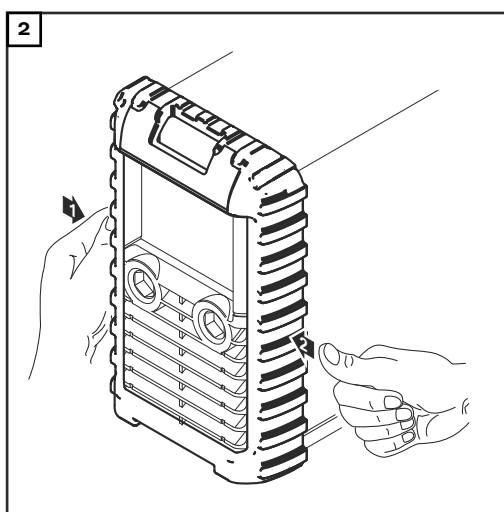
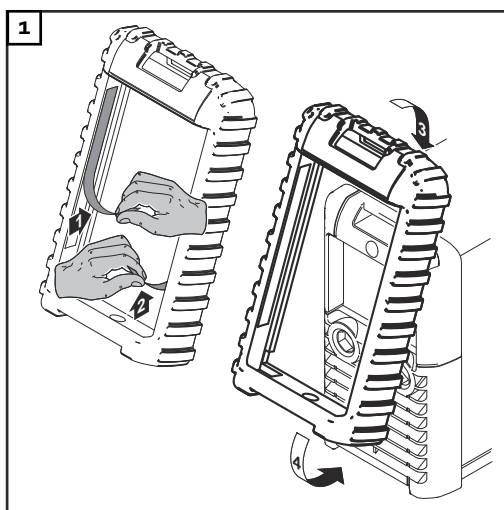

**IMPORTANT!** If the edge guard is to remain fitted to the charger permanently, peel the cover strips off the adhesive strips.

## Mounting on the wall

Fit the charger to the wall using the optional wall bracket:

### NOTE!

**If fixing to the wall, please note the weight of the charger.** Only fix to a wall that is suitable to this purpose.

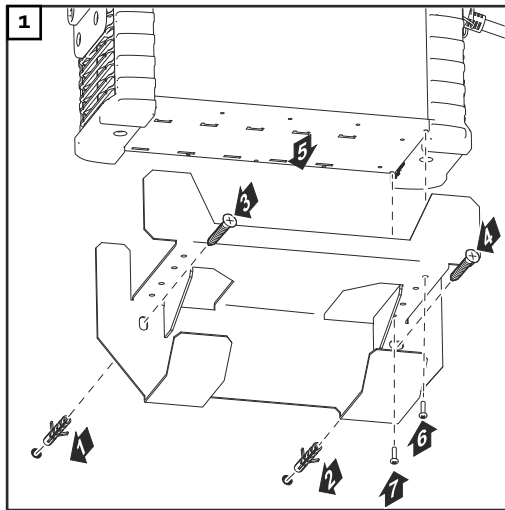

- Fasten the wall bracket to a suitable wall surface using dowels and screws
- Position charger on wall bracket

The base of the charger must lie flat on the wall bracket.

- Only if the charger is being fitted permanently to the wall bracket: Fasten the charger to the bracket using the two screws supplied (diameter 3.5 x 9.5 mm)

### Fitting to the floor

Fit the charger to the floor using the optional fitting brackets:

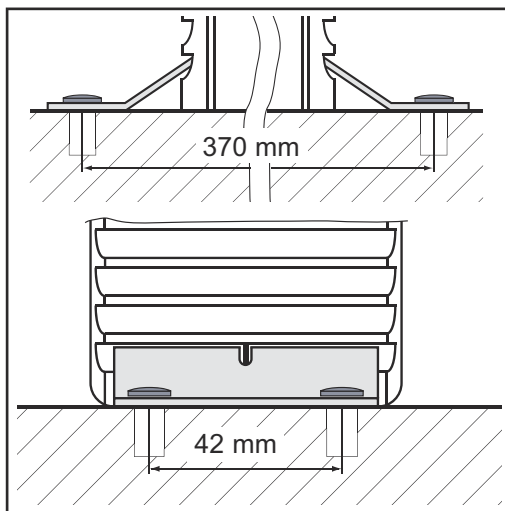





- 1 Insert the fitting bracket into the left and right-hand sides of the ventilation grille on the charger's front panel, and do the same on the rear panel
- 2 Mark the location of the holes on the mounting surface (see diagram for measurements)
- 3 Drill holes
- 4 Select the most suitable screws for fastening the charger according to the nature of the mounting surface (diameter 5 mm)
- 5 Fasten charger to the mounting surface using fitting brackets, each with two screws

# Operating modes

## Available operating modes

Overview of available operating modes. Important additional information on the individual operating modes can be found in the following sections.

	<p>Standard charging</p> <ul style="list-style-type: none"> <li>- For batteries with liquid electrolyte (Pb, GEL, Ca, Ca silver)</li> <li>- For batteries with fixed electrolyte (AGM, MF, sealant)</li> </ul>
	<p>Refresh charging</p> <ul style="list-style-type: none"> <li>- For reactivating batteries with liquid electrolyte (Pb, GEL, Ca, Ca silver)</li> <li>- For reactivating batteries with fixed electrolyte (AGM, MF, sealant)</li> </ul>
	<p>User charging</p> <ul style="list-style-type: none"> <li>- Additional charge mode for batteries with liquid electrolyte (Pb, GEL, Ca, Ca silver)</li> <li>- Additional charge mode for batteries with fixed electrolyte (AGM, MF, sealant)</li> </ul>
	<p>External power supply External power supply to consumers and backup for the vehicle battery</p>
	<p>Charge acceptance test For testing a battery's ability to accept a charge</p>

## Standard charging mode

The standard charging mode should be used for:

- charging / conservation charging with battery either fitted or removed
- trickle mode (to charge the battery when consumers in the vehicle are switched on)

## Refresh charging mode

 **CAUTION!**

### **Danger of damage to the in-car electronics by refresh charging.**

Before beginning refresh charging, disconnect battery from vehicle power supply.

Refresh charging mode is used to charge the battery if it is suspected that the battery has been deeply discharged over a long period (e.g. battery sulphated)

- battery is charged to maximum acid concentration
- plates are reactivated (degradation of sulphate layer)

**IMPORTANT!** The success of refresh charging depends on the degree of sulphation of the battery.

## NOTE!

### refresh charging may only be used when:

- ▶ the battery capacity has been correctly set
  - ▶ refresh charging takes place in a well-ventilated area
- 

### User charging mode

User charging is an additional charging mode in which charging parameters for the device can be specified individually.

The parameters for user charging mode are preset in the factory for standby applications (e.g. emergency power systems) or for ambient temperatures  $> 35^{\circ}\text{C}$  ( $95^{\circ}\text{F}$ ).

The user charging mode should be used for:

- charging / conservation charging with battery either fitted or removed
  - trickle mode (to charge the battery when consumers in the vehicle are switched on)
- 

### External power supply mode

The external power supply mode is to ensure consumers have a power supply

- when there is increased power consumption (e.g. updating firmware/software for the vehicle's electronics),
  - in back-up mode, to supply power to the on-board electronic systems while the battery is being changed (to avoid losing settings such as time, radio settings, etc.).
- 

### Charge acceptance test mode

Charge acceptance test mode is used to test a battery's ability to accept a charge. The test takes place as follows:

- the automatic charge acceptance test takes only a few minutes
- the charge acceptance test is ended after a predefined period has elapsed
- if the result is positive, the device will switch automatically to standard charging mode and charge the battery
- if the result is negative, „Test Fail“ appears on the charger's screen and charging of the battery is halted.



# Charging the battery

## Starting charging

### ⚠ CAUTION!

#### Risk of damage when attempting to charge a faulty battery.

Before charging, ensure that the battery to be charged is fully functional.

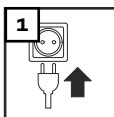

### ⚠ CAUTION!

#### When refresh charging is selected: risk of damage of the on-board electronics by refresh charging.

Before beginning refresh charging, disconnect battery from vehicle power supply.

- 2 Select the corresponding operating mode by pressing the info button



- 3 Set the capacity of the battery to be loaded using the „up“ and „down“ buttons



After the battery capacity has been set, the charging current calculated from this is shown on the display.

- 4 Connect (+) charging terminal to positive pole on battery  
 5 Connect (-) charging terminal to negative pole on the battery, or to vehicle body (e.g. engine block) in the case of vehicle electrical systems.

Charger detects that the battery is connected, carries out a self test and starts charging.

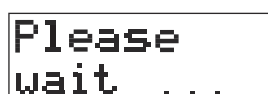

Self test



E.g.: charging



**IMPORTANT!** If the battery voltage is < 1.0 V, the battery will not be automatically detected. Charging must be started manually.

### Retrieving parameters during charging

- 1 Press the info button during charging



The actual charging current is displayed:



*E.g.: actual charging current*

By repeated pressing the info button, the other parameters are displayed in the following sequence:



*E.g.: actual battery voltage*



*E.g.: amount of charge fed in*



*E.g.: energy fed in*



*E.g.: length of time charging so far*

The top half of the display shows current progress and the bottom half shows the relevant values.

### Deep-discharge battery: starting charging manually



#### CAUTION!

#### **Risk of serious damage as a result of incorrectly connected charging terminals.**

The reversal polarity protection facility is inoperative if charging is started manually (battery voltage < 1.0 V).

Connect charging terminals to correct poles and ensure proper electrical connection to vehicle terminals.

- 1 Connect (+) charging terminal to positive pole on battery
- 2 Connect (-) charging terminal to negative pole on the battery, or to vehicle body (e.g. engine block) in the case of vehicle electrical systems.
- 3 Press start/stop button for approx. 5 secs 

A query regarding correct polarity of the charging terminals is displayed:

ok?  
↵

Starting the charging process confirms the correct polarity connection. If there is no confirmation of correct pole connection within 2.5 secs, the device reverts to menu mode.

- 4 Ensure charging terminals are connected to correct poles
- 5 Start charging by pressing the start/stop button 

The charger starts charging.

Please  
wait ...

▣\_ \_ \_ ▣  
113Ah →▣

#### Display of charge progress during charging

▣\_ \_ \_ ▣  
113Ah →▣

During charging, the number of bars indicates how charging is progressing.

▣\_ \_ \_ \_ ▣  
113Ah →▣

Final charging stage - once the battery is approx. 80 - 85 % charged.

- Display shows 6 consecutive bars
- Battery is now ready for use

**IMPORTANT!** the charger automatically switches over to conservation charging after approx. 3 - 7 hours, depending on the type of battery. To charge the battery completely, the battery should remain connected to the charger for this length of time.

#### NOTE!

**Only in Refresh charging mode: When refresh charging has finished, the machine switches off.**

Conservation charging does not take place.

▣\_ \_ \_ \_ \_ ▣  
125Ah →▣

When the battery is fully charged, the charger begins conservation charging.

- all bars are permanently displayed
- The battery is 100 % charged.
- Battery is always ready to use.
- Battery can remain connected to charger for as long as required.
- Conservation charging counteracts battery selfdischarge.

## NOTE!

To compensate, the charger can briefly increase the current to the maximum charging current (see Technical Data, user-defined settings in USER menu).

### Interrupting charging / re-summing charging

- 1 Press Start/Stop button to interrupt charging 



< STOP >  
72Ah → 

- 2 Press Start/Stop button again to resume charging 

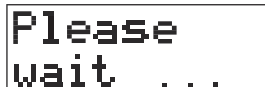

Please  
wait ...  
Self test



72Ah → 

E.g.: charging continues

### Retrieving parameters when charging has stopped

Charging was interrupted by pressing the start/stop button.

- 1 Press the info button 

The actual charging current is displayed:



< STOP >  
0,0A → 

E.g.: actual charging current

By repeated pressing the info button, the other parameters are displayed in the following sequence:





< STOP >  
13,3V → 

E.g.: actual battery voltage



< STOP >  
95Ah → 

E.g.: amount of charge fed in



< STOP >  
1Wh → 

E.g.: energy fed in



< STOP >  
10:00 → 

E.g.: length of time charging so far

The top half of the display shows < STOP > and the bottom half shows the relevant values.

**Finishing charging and disconnecting the battery**

**⚠ WARNING!**

**Risk of explosion due to sparking when disconnecting the charging terminals.**

Before disconnecting the charging terminals, stop charging by pressing the start/stop button and possibly provide adequate ventilation.

- 1 Finish charging by pressing the start/stop button 



- 2 Disconnect (-) charging terminal from battery
- 3 Disconnect (+) charging terminal from battery

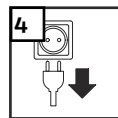

# External power supply

## Starting the external power supply

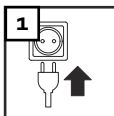

- 2 Select FSV/SPLY mode by pressing the info button 



FSV/SPLY  
13,5V

- 3 Connect (+) charging terminal to positive pole on battery  
4 Connect (-) charging terminal to negative pole on the battery, or to vehicle body (e.g. engine block) in the case of vehicle electrical systems

Charger detects that the battery is connected, carries out a self test and starts external power supply.

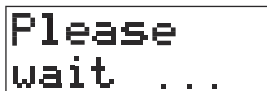

Please  
wait ...

*Self test*



IU 13,5V  
30,0A

- the maximum voltage command value set in the USER menu is shown in the top half of the display.
- the current parameters are shown in the bottom half of the display.

By pressing the info button, the parameters are displayed in the following sequence:

- actual charging current
- actual battery voltage
- amount of charge (Ah) fed in so far
- energy (Wh) fed in so far
- length of time charging so far

**IMPORTANT!** Start external power supply manually if:

- there is no battery connected to the vehicle
- the battery voltage on the connected battery is  $< 1.0$  V

## Starting the external power supply manually

### CAUTION!

**Risk of serious damage as a result of incorrectly connected charging terminals.**

The reverse polarity protection facility is inoperative if the external power supply is started manually.

Connect charging terminals to correct poles and ensure proper electrical connection to vehicle terminals.

- 1 Connect (+) charging terminal to positive pole on battery
- 2 Connect (-) charging terminal to negative pole on the battery, or to vehicle body (e.g. engine block) in the case of vehicle electrical systems
- 3 press start/stop button for approx. 5 secs 

A query regarding correct polarity of the charging terminals is displayed:

ok?

Starting the external power supply confirms the correct polarity connection. If the external power supply is not started within 2.5 secs, the device reverts to menu mode.

- 4 Ensure charging terminals are connected to correct poles
- 5 Start external power supply by pressing the start/stop button 

The charger starts the external power supply.

IU 13,5V  
0,3A →

### Boost mode

If the battery voltage drops while power is being supplied externally because more power is needed (e.g. because additional consumer loads are switched on), the device goes into boost mode.

BOOST!  
63,2A →

**IMPORTANT!** To maintain the battery voltage at a constant level, the charger can increase the current in boost mode to the maximum charging current (see Technical Data).

To prevent the device overheating, the max. output current can be automatically limited if the ambient temperature is high (power derating).

### Stopping the external power supply and disconnecting the charging terminals



#### WARNING!

**Risk of explosion due to sparking when disconnecting the charging terminals.**

Before disconnecting the charging terminals, stop external power supply by pressing the start/stop button and possibly provide adequate ventilation.

- 1 Stop the external power supply by pressing the start/stop button 

< STOP >  
13,3V →

By pressing the info button, the parameters are displayed in the following sequence:

- actual charging current
- actual battery voltage
- amount of charge (Ah) fed in so far
- energy (Wh) fed in so far
- length of time charging so far

**2** Disconnect (-) charging terminal from battery

**3** Disconnect (+) charging terminal from battery

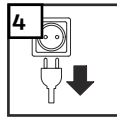



# Charge acceptance test

## General

Charge acceptance test mode is used to determine a battery's ability to accept a charge.

The charge acceptance test takes place as follows:

- charge acceptance testing is conducted automatically for a period of 15 minutes; if the result is positive, the device will then switch automatically to standard charging mode and charge the battery
- if the result is negative, „Test Fail“ appears on the charger's screen and charging of the battery is halted

A prerequisite for a satisfactory charge acceptance test is compliance with EU standard EN-50342-1:2006 item 5.4 (battery approx. 50% discharged).

## Preparations

To ensure the battery is about 50% discharged, the following preparations can be carried out immediately before the charge acceptance test:

- 1 Fully charge the battery
- 2 Calculate the discharge current:

$$\text{discharge current} = \frac{\text{battery capacity (Ah)}}{10}$$

- 3 Charge battery for approx. 5 hours with the calculated discharge current

## Start the charge acceptance test

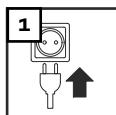

- 2 Select the charge acceptance test mode by pressing the info button 



- 3 Set the capacity of the battery to be tested using the „up“ and „down“ buttons



- 4 Connect (+) charging terminal to positive pole on battery
- 5 (Connect (-) charging terminal to negative pole on the battery, or to vehicle body (e.g. engine block) in the case of vehicle electrical systems

Charger detects that the battery is connected, carries out a self-test and starts the charge acceptance test.

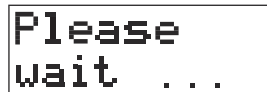

Self test



Charge acceptance test

### Starting the charge acceptance test manually

#### CAUTION!

#### **Risk of serious damage if the charging terminals are connected incorrectly.**

The reverse polarity protection facility is inoperative if the current input test is started manually (battery voltage < 1.5 V).

Connect charging terminals to correct poles and ensure proper electrical connection to vehicle terminals.

- 1 Connect (+) charging terminal to positive pole on battery
- 2 Connect (-) charging terminal to negative pole on the battery, or to vehicle body (e.g. engine block) in the case of vehicle electrical systems.

- 3 Press start/stop button for approx. 5 secs   
A query regarding correct polarity of the charging terminals is displayed:



Starting the charge acceptance test confirms the correct polarity connection. If the charge acceptance test is not started within 2.5 secs, the device reverts to menu mode.

- 4 Ensure charging terminals are connected to correct poles
- 5 Start the charge acceptance test by pressing the start/stop button   
The charger starts the charge acceptance test.

### Retrieving parameters during the charge acceptance test

By pressing the info button, the parameters are displayed in the following sequence:

- actual battery current
- actual battery voltage
- amount of charge (Ah) fed in so far
- energy (Wh) fed in so far
- time that has elapsed since the start of the test

### Charge acceptance test finished - battery OK

The battery is OK, when the charger will switch automatically to standard charging mode and charge the battery after the charge acceptance test has been carried out.

By pressing the Info button stored test parameters and the actual charging parameters can be viewed: 



E.g.: actual charging current

- the top half of the display features progress bars to show the progress of the current charging operation
- the bottom half of the display shows the current charging parameters / calculated test parameters

By repeated pressing the info button, the other parameters are displayed in the following sequence: 

Charging parameters:



E.g.: actual battery voltage



E.g.: amount of charge fed in



E.g.: energy fed in



E.g.: length of time charging so far

Test parameters: can be identified by the test symbol 



E.g.: charging current



E.g.: battery voltage



E.g.: set battery capacity



E.g.: Battery's capacity to accept charge, expressed in %

**Charge acceptance test finished - battery faulty**

**IMPORTANT!** A fully-charged battery can also return a negative test result. In this case the battery must be discharged (see chapter entitled Charge acceptance test - Preparations).

The charge acceptance test shows that the battery is faulty. The battery receives no further charge. The result is displayed on the screen:



E.g.: charging current

- the top half of the display shows „Test Fail“ at a negative result of the charge acceptance test
- the bottom half of the display shows the calculated parameters

By pressing the Info button the following parameters can be retrieved: 

```
TestFail  
a> 10,0V
```

*E.g.: battery voltage*

```
TestFail  
a> 123Ah
```

*E.g.: set battery capacity*

```
TestFail  
a> 0,6%
```

*E.g.: Battery's capacity to accept charge, expressed in %*

If the terminals are disconnected from the battery in this mode, the charger reverts to the Operating Mode menu.

# Setup menu

**General remarks** The setup menu gives you the ability to configure the device's basic settings according to your own requirements. You can also store frequently used charge settings.

## **WARNING!**

### **Operating the equipment incorrectly can cause serious damage.**

The functions described must only be carried out by trained and qualified personnel. In addition to the safety rules in these operating instructions, the safety rules of the battery and vehicle manufacturers must also be followed.

## Setup menu - overview

USER  
U/I

### **USER U/I**

Setting of following parameters:

- maximum charging current (standard charging)
- main charging voltage (standard charging)
- conservation charging voltage (standard charging)
- safety cut-out (standard charging)
- maximum charging current (user charging)
- main charging voltage (user charging)
- conservation charging voltage (user charging)
- safety cut-out (user charging)
- maximum external power supply
- external power supply voltage
- refresh charging voltage
- refresh charging period
- exit USER U/I menu

PRESET

### **PREFERRED SETTINGS**

Saves the frequently used operating modes you wish to keep once the charger leads are removed or the charger is disconnected from the mains

CHARGING  
CABLE

### **CHARGING CABLE**

Settings defining the length and cross-section of the charging cable

FACTORY  
SETTING

### **FACTORY SETTING**

Resets device to factory setting

DELAY  
TIME

### **DELAY TIME**

Sets the charging start delay time. Charging starts after a predefined period.

DEVICE  
VERSION

### **DEVICE VERSION**

For querying the current hardware and firmware version

DEVICE  
HISTORY



### **DEVICE HISTORY**

Checking operating hours counter

EXIT  
SETUP

**EXIT SETUP**  
Exits the setup menu

### Accessing setup menu

- 1 To access menu: press info button for approx. 5 secs 
- 2 Select menu item using the „up“ and „down“ buttons 
- 3 Enter the selected menu item by pressing the start/stop button 

**IMPORTANT!** If no selection is made within 30 seconds, the setup menu is exited automatically.



### Setting parameters in the USER U/I menu

- 1  

The screen to enter the access code is displayed:

⌘  
3111

Enter access code 3831:

- 2 Using the „up“ and „down“ buttons, enter the correct digit in the underlined position 
- 3 Press the info button to go to the next position 
- 4 Repeat steps 2 and 3 until all four digits have been entered correctly

⌘  
3831



- 5 Press the start/stop button to confirm the access code is correct 

The first parameter in the USER U/I menu is displayed.

#### Setting parameter - general:

- 6 Select the desired parameter using the „up“ and „down“ buttons 
- 7 Press the start/stop button 

Display flashes.

- 8 Adjust the desired value of the selected parameter using the „up“ and „down“ buttons 
- 9 Press the start/stop button to save the value 

#### Parameters in the USER U/I menu



I Chrg  
45,5A

I Chrg  
45,5A ↑↓

maximum charging current (standard charging)  
Setting range: see Technical Data, in steps of 0,5 A

U1 Chrg  
15,1V

U1 Chrg  
15,1V ↑↓

main charging voltage (standard charging)  
setting range: 12.0 - 15.5 V, in steps of 0.1 V

U2 Chrg  
15,1V

U2 Chrg  
15,1V ↑↓

conservation charging voltage (standard charging)  
setting range: Off / 12.0 - 15.5 V, in steps of 0.1 V

**IMPORTANT!** the conservation charging voltage is only available in Charge mode. Conservation charging does not take place if conservation charging is set to OFF. However, if the battery voltage drops below 12 V, charging starts

t Chrg  
10:00

t Chrg  
10:00 ↑↓

safety cut-out (standard charging)  
setting range: 2 h - 30 h, in 10 min intervals

**IMPORTANT!** If charging does not end automatically after the set time has elapsed, the charger will be switched off as a safety precaution.

I User  
45,5A

I User  
45,5A ↑↓

maximum charging current (user charging)  
Setting range: see Technical Data, in steps of 0.5 A



U1 User  
15,1V

U1 User  
15,1V ↑↓

main charging voltage (user charging)  
setting range: 12.0 - 15.5 V, in steps of 0.1 V

U2 User  
15,1V

U2 User  
15,1V ↑↓

conservation charging voltage (user charging)  
setting range: Off / 12.0 - 15.5 V, in steps of 0.1 V

**IMPORTANT!** Conservation charging does not take place if conservation charging is set to OFF. However, if the battery voltage drops below 12 V, charging starts.

t User  
10:00

t User  
10:00 ↑↓

safety cut-out (user charging)  
setting range: 2 h - 30 h, in 10 min intervals

**IMPORTANT!** If charging does not end automatically after the set time has elapsed, the charger will be switched off as a safety precaution..

I FSU/SP  
45,5A

I FSU/SP  
45,5A ↑↓

maximum external power supply  
Setting range: see Technical Data, in steps of 0.5 A

U FSU/SP  
15,1V

U FSU/SP  
15,1V ↑↓

external power supply voltage  
setting range: 12.0 - 15.5 V, in steps of 0.1 V

U refres  
15,1V ↑↓

U refres  
15,1V ↑↓

refresh charging voltage  
setting range: 12.0 - 17.0 V, in steps of 0.1 V

t refres  
10:00 ↑↓

t refres  
10:00 ↑↓

refresh charging period  
setting range: 2 h - 30 h, in 10 min intervals



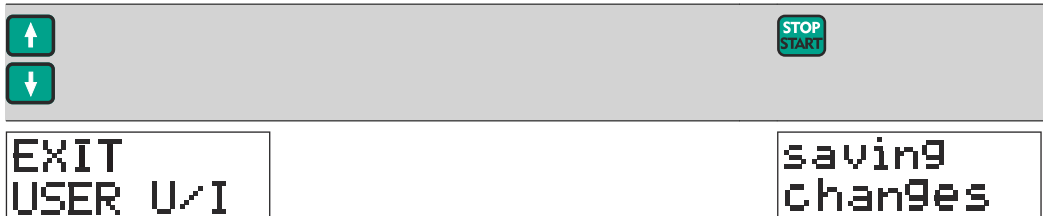

to exit the USER U/I menu

### PRESET menu - setting preferred operating modes

**IMPORTANT!** To avoid damage to the vehicle electronics, the refresh charging mode cannot be saved.



2 Select one of the following operating modes using the „up“ and „down“ buttons 

Preset  
UsedMode

**Preferred Setting Used Mode** (factory setting)  
After disconnecting the charging terminals or mains supply, the last mode selected is saved.

Preset  
to Check

**Preferred Setting: charge acceptance test mode**  
After disconnecting the charging terminals or mains supply, the charge acceptance test mode is saved.

Preset  
Charge

**Preferred Setting: standard charging mode**  
After disconnecting the charging terminals or mains supply, the standard charging mode is saved.

Preset  
User

**Preferred Setting: user charging mode**  
After disconnecting the charging terminals or mains supply, the user charging mode is saved.

Preset  
FSU/SPLY

**Preferred Setting: external power supply mode**  
After disconnecting the charging terminals or mains supply, the external power supply mode is saved.

3 Save the desired mode by pressing the start/stop button 

Preset  
saved

**IMPORTANT!** Regardless of the „preferred setting“ saved, another mode can be selected at any time. After disconnecting the charging terminals or mains supply, the device automatically reverts to the saved „preferred setting“.

**CHARGING  
CABLE menu -  
setting charging  
cable data**

- 1  

The length of the charger cable is displayed.



- 2 If necessary, change measure (metric/imperial) by pressing the info button 





- 3 To adjust the length of the charger cable press the start/stop button 

The length of the charger cable flashes.



- 4 Set the length of the charger cable using the „up“ and „down“ buttons  
Setting range: 1 to 25 m (3 ft. 3 in. to 82 ft.) 

- 5 To save the length of the charger cable press the start/stop button 

- 6 Select the cross-section of the charger cable using the „up“ and „down“ buttons 



- 7 To adjust the cross-section of the charger cable press the start/stop button 

The cross-section of the charger cable flashes.



- 8 Set the the cross-section of the charger cable using the „up“ and „down“ buttons  
 Setting range: 4 - 6 - 10 - 16 - 25 - 35 - 50 mm<sup>2</sup> (AWG 10 bis AWG 1)

- 9 To save the cross-section of the charger cable press the start/stop button 

- 10 Select EXIT CH. CABLE using the „up“ and „down“ buttons 

```
EXIT
CH. CABLE
```

- 11 Press Start/Stop button to exit 

### FACTORY SETTING menu - Reset device to factory setting

- 1 

```
FACTORY
SETTING
```



„Device resetted“ appears for 1 second.

```
Device
resetted
```

Device has been reset to factory setting. The submenu is exited automatically.

### DELAY TIME menu - setting the delay time



- 1 

```
DELAY
TIME
```



The delay time flashes.

```
delay
1:03- ↑↓
```

- 2 Set the desired delay time using the „up“ and „down“ buttons  
Setting range: 0 - 4 h 
- 3 To save the delay time press the start/stop button 

```
Delay
saved
```

**IMPORTANT!** Delay time must be set again after each cycle. If the power fails, the countdown stops. Once the power is restored, the countdown continues where it left off.

---

**DEVICE VER-  
SION menu -  
viewing device  
data**

1  

2 Select one of the following views using the „up“ and „down“ buttons 

---



**Firmware**  
Displays the firmware version

---



**Boot programm**  
Displays the boot program version

---



**Hardware**  
Displays the hardware version installed on the device

---



**Exit**  
Press start/stop button to exit the DEVICE VER-  
SION menu 

---

---

**DEVICE HIS-  
TORY menu -  
querying operat-  
ing hours**

1  

2 Select one of the following views using the „up“ and „down“ buttons 

---



**Operating Hours**  
Shows the operating hours (device connected to the mains or switched on)

---



**Charging Hours**  
Displays the operating time (time during which the device has been producing power)

---



**Cumulated Ampere Hours**  
Displays the amount of charge produced

---



**Exit**  
Press the start/stop button to exit the DEVICE HISTORY menu 

---

Troubleshooting

**Charging terminals connected to wrong poles**

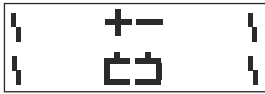

Cause Charging terminals connected to wrong poles  
 Remedy Swap charging terminals round

**Charging terminals short-circuited**

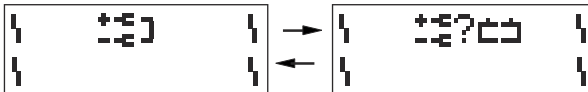

Cause Short-circuit on the charging terminals  
 Remedy Rectify short-circuit on the charging terminals

Cause Battery not detected  
 Remedy Check that charging terminals are properly connected, press Start/Stop button for 5 seconds

**Over-temperature**



Cause Over-temperature - charger too hot  
 Remedy Allow charger to cool down

Cause Air inlets and outlets covered  
 Remedy Ensure air inlets and outlets are not obstructed

**Safety cut-out**



Cause Battery faulty  
 Remedy Check battery

Cause Charger incorrectly set  
 Remedy Check settings: Ah, voltage

Cause Incorrect battery type (e.g. NiCd), incorrect number of cells (voltage)  
 Remedy Check battery type

**Fan blocked/faulty**



Cause	Fan blocked
Remedy	Check air inlet, remove foreign bodies if necessary
Cause	Fan faulty
Remedy	Contact specialist dealer

---

#### **Fuse faulty**



Cause	Secondary fuse faulty
Remedy	Contact specialist dealer

---

#### **Charger faulty**



Cause	Charger faulty
Remedy	Contact specialist dealer

---

#### **Nothing on display**

Cause	Mains supply interrupted
Remedy	Connect mains supply
Cause	Mains plug or mains cable faulty
Remedy	Replace mains plug or mains cable
Cause	Charger faulty
Remedy	Contact specialist dealer

---

#### **Charger does not start charging**

Cause	Charging terminals or charger lead faulty
Remedy	Replace charging terminals or charger lead (M8 nut torque = 15 Nm)

---

# Symbols used

## Warning notices affixed to the charger



Follow operating instructions



Connect battery poles correctly:  
(+) red (-) black



Detonating gas is generated in the battery during charging.  
Risk of explosion!



The charger heats up depending on operating conditions.



Before disconnecting the charger lead from the battery, interrupt charging.



Chargers may only be opened by a qualified electrician



Avoid flames and sparks during charging.



Ensure adequate ventilation during charging.



Battery acid is corrosive.



For indoor use only.  
Do not expose to rain.

# Technical data

<b>Acctiva Professional Flash, Acctiva Professional Flash AUS, Acctiva Professional Flash JP, Acctiva Professional 30A JP</b>	Mains voltage (+/- 15%)		
	Acctiva Professional Flash	230 V AC, 50/60 Hz	
	Acctiva Professional Flash AUS	240 V AC, 50/60 Hz	
	Acctiva Professional Flash JP	100 V AC, 50/60 Hz	
	Acctiva Professional 30A JP	100 V AC, 50/60 Hz	
	Nominal output max.		
	Acctiva Professional Flash	1080 W	
	Acctiva Professional Flash AUS	1080 W	
	Acctiva Professional Flash JP	1080 W	
	Acctiva Professional 30A JP	710 W	
	Charging voltage		12,0 - 15,5 V
	Charging current I <sub>2</sub> (adjustable)		
	Acctiva Professional Flash	2 - 50 A	
	Acctiva Professional Flash AUS	2 - 50 A	
	Acctiva Professional Flash JP	2 - 50 A	
	Acctiva Professional 30A JP	2 - 30 A	
	Boost mode charging current t <sub>2 max</sub> (tI <sub>2 max</sub> = 30 s, tI <sub>2</sub> = 60 s)		
	Acctiva Professional Flash	max. 70 A	
	Acctiva Professional Flash AUS	max. 70 A	
	Acctiva Professional Flash JP	max. 70 A	
	Acctiva Professional 30A JP	max. 30 A	
	Nominal charging capacity		10 - 250/300 Ah
	Number of cells		6
Charging characteristic		IUoU / IUa / IU	
Operating temperature *		0 °C to +60 °C 32 °F to 140 °F	
Storage temperature		-20 °C to +80 °C 4 °F to 176 °F	
Interface		USB	
EMC Class			
Acctiva Professional Flash	IEC/EN 61000-6-4/2 (EMC class A)		
Acctiva Professional Flash AUS	IEC/EN 61000-6-4/2 (EMC class A)		
Acctiva Professional Flash JP	IEC/EN 61000-6-4 (EMC class A)		
Acctiva Professional 30A JP	J 55014		
Protection		IP 20	
Marks of conformity		see charger rating plate	
Weight inclusive of mains and charger leads		6,5 kg 14.33 lb.	
Dimensions w x h x d		315 x 200 x 110 mm 12.40 x 7.87 x 4.33 in.	

\* If the ambient temperature rises to above 35°C (95°F) or thereabouts (depending on secondary voltage), the secondary output current is reduced (power derating)











**Fronius International GmbH**

Froniusstraße 1  
4643 Pettenbach  
Austria  
contact@fronius.com  
www.fronius.com

Under [www.fronius.com/contact](http://www.fronius.com/contact) you will find the addresses of all Fronius Sales & Service Partners and locations.