

Operating Instructions

Ignis 150 TIG
Ignis 180 TIG

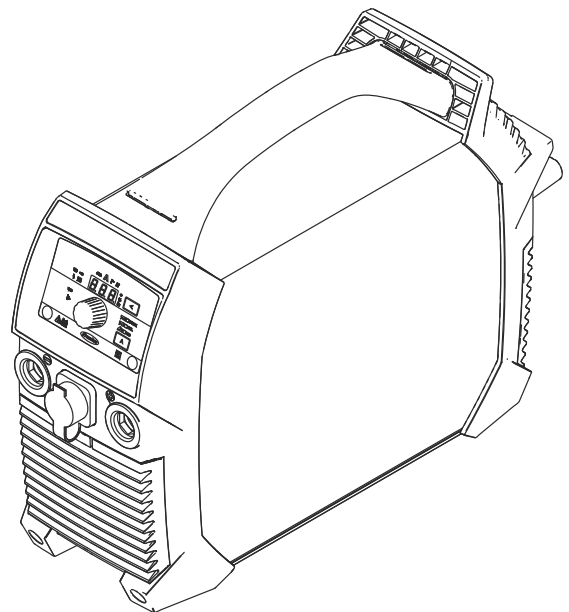

EN | Operating Instructions



Contents

Safety rules.....	5
Explanation of safety notices	5
General.....	5
Proper use	6
Environmental conditions.....	6
Obligations of the operator.....	6
Obligations of personnel.....	6
Mains connection.....	7
Residual current protective device.....	7
Protecting yourself and others.....	7
Noise emission values	8
Danger from toxic gases and vapours.....	8
Danger from flying sparks	9
Risks from mains current and welding current.....	9
Meandering welding currents	10
EMC Device Classifications.....	10
EMC measures.....	11
EMF measures.....	11
Specific hazards.....	11
Requirement for the shielding gas.....	12
Danger from shielding gas cylinders.....	13
Safety measures at the installation location and during transport.....	13
Safety measures in normal operation.....	14
Commissioning, maintenance and repair.....	14
Safety inspection.....	15
Disposal.....	15
Safety symbols.....	15
Data protection	16
Copyright.....	16
General.....	17
Device concept.....	17
Warning notices on the device.....	17
Application areas.....	18
Before commissioning.....	19
Safety	19
Intended use.....	19
Setup regulations	19
Generator-powered operation.....	20
Controls, connections and mechanical components.....	21
Safety	21
Ignis 150 controls, connections and mechanical components.....	22
Ignis 180 controls, connections and mechanical components.....	23
Control panel.....	24
MMA welding	26
Preparation.....	26
MMA welding	27
SoftStart / HotStart function	27
Arc-force dynamic.....	28
Pulse welding.....	29
TIG modes.....	31
Symbols and their explanations.....	31
2-step mode.....	31
4-step mode.....	32
TIG welding.....	33
General.....	33
Connecting the gas cylinder	33
Preparation.....	34
Setting the gas pressure	35
TIG welding.....	35
TIG Comfort Stop.....	36

Pulse welding.....	37
Tacking function.....	38
Welding process Setup menu.....	40
Accessing the Setup menu.....	40
Changing welding parameters.....	40
Exiting the Setup menu.....	40
Parameters for MMA welding.....	40
Parameters for TIG welding.....	42
Setup menu - Level 2.....	44
Welding parameters in the level 2 Setup menu.....	44
Care, maintenance and disposal.....	46
Safety.....	46
General.....	46
Maintenance at every start-up.....	46
Maintenance every 2 months.....	47
Disposal.....	47
Troubleshooting.....	48
Safety.....	48
Indicated errors.....	48
Service messages.....	48
No function.....	50
Faulty operation.....	51
Average consumption values during welding.....	53
Average wire electrode consumption during MIG/MAG welding.....	53
Average shielding gas consumption during MIG/MAG welding.....	53
Average shielding gas consumption during TIG welding.....	53
Technical data.....	54
Explanation of the term "duty cycle".....	54
Ignis 150 TIG.....	54
Ignis 180 TIG.....	55
Ignis 180 TIG MV.....	56
Overview with critical raw materials, year of production of the device.....	58

Safety rules

Explanation of safety notices

DANGER!

Indicates immediate danger.

- ▶ If not avoided, death or serious injury will result.
-

WARNING!

Indicates a potentially hazardous situation.

- ▶ If not avoided, death or serious injury may result.
-

CAUTION!

Indicates a situation where damage or injury could occur.

- ▶ If not avoided, minor injury and/or damage to property may result.
-

NOTE!

Indicates a risk of flawed results and possible damage to the equipment.

General

The device is manufactured using state-of-the-art technology and according to recognised safety standards. If used incorrectly or misused, however, it can cause:

- injury or death to the operator or a third party,
 - damage to the device and other material assets belonging to the operating company,
 - inefficient operation of the device.
-

All persons involved in commissioning, operating, maintaining and servicing the device must:

- be suitably qualified,
 - have sufficient knowledge of welding and
 - read and follow these operating instructions carefully.
-

The operating instructions must always be at hand wherever the device is being used. In addition to the operating instructions, attention must also be paid to any generally applicable and local regulations regarding accident prevention and environmental protection.

All safety and danger notices on the device

- must be in a legible state,
 - must not be damaged,
 - must not be removed,
 - must not be covered, pasted or painted over.
-

For the location of the safety and danger notices on the device, refer to the section headed "General" in the operating instructions for the device.

Before switching on the device, rectify any faults that could compromise safety.

This is for your personal safety!

Proper use

The device is to be used exclusively for its intended purpose.

The device is intended solely for the welding processes specified on the rating plate.

Any use above and beyond this purpose is deemed improper. The manufacturer shall not be held liable for any damage arising from such usage.

Proper use includes:

- carefully reading and following all the instructions given in the operating instructions
 - studying and obeying all safety and danger notices carefully
 - performing all stipulated inspection and maintenance work.
-

Never use the device for the following purposes:

- Thawing out pipes
 - Charging batteries
 - Starting engines
-

The device is designed for use in industry and the workshop. The manufacturer accepts no responsibility for any damage caused through use in a domestic setting.

The manufacturer likewise accepts no liability for inadequate or incorrect results.

Environmental conditions

Operation or storage of the device outside the stipulated area will be deemed as not in accordance with the intended purpose. The manufacturer shall not be held liable for any damage arising from such usage.

Ambient temperature range:

- during operation: -10 °C to + 40 °C (14 °F to 104 °F)
 - during transport and storage: -20 °C to +55 °C (-4 °F to 131 °F)
-

Relative humidity:

- up to 50% at 40 °C (104 °F)
 - up to 90% at 20 °C (68 °F)
-

The surrounding air must be free from dust, acids, corrosive gases or substances, etc.

Can be used at altitudes of up to 2000 m (6561 ft. 8.16 in.)

Obligations of the operator

The operator must only allow persons to work with the device who:

- are familiar with the fundamental instructions regarding safety at work and accident prevention and have been instructed in how to use the device
 - have read and understood these operating instructions, especially the section "safety rules", and have confirmed as much with their signatures
 - are trained to produce the required results.
-

Checks must be carried out at regular intervals to ensure that operators are working in a safety-conscious manner.

Obligations of personnel

Before using the device, all persons instructed to do so undertake:

- to observe the basic instructions regarding safety at work and accident prevention
 - to read these operating instructions, especially the "Safety rules" section and sign to confirm that they have understood them and will follow them.
-

Before leaving the workplace, ensure that people or property cannot come to any harm in your absence.

Mains connection

Devices with a higher rating may affect the energy quality of the mains due to their current consumption.

This may affect a number device types in terms of:

- Connection restrictions
- Criteria with regard to the maximum permissible mains impedance ^{*)}
- Criteria with regard to the minimum short-circuit power requirement ^{*)}

^{*)} at the interface with the public grid
see "Technical data"

In this case, the plant operator or the person using the device should check whether the device may be connected, where appropriate by discussing the matter with the power supply company.

IMPORTANT! Ensure that the mains connection is earthed properly

Residual current protective device

Local regulations and national guidelines may require a residual current protective device when connecting equipment to the public grid.
The type of residual current protective device recommended by the manufacturer for the equipment is indicated in the technical data.

Protecting yourself and others

Anyone working with the device exposes themselves to numerous risks, e.g.

- flying sparks and hot pieces of metal
- Arc radiation, which can damage eyes and skin
- Hazardous electromagnetic fields, which can endanger the lives of those using cardiac pacemakers
- Risk of electrocution from mains current and welding current
- Greater noise pollution
- Harmful welding fumes and gases

Suitable protective clothing must be worn when working with the device. The protective clothing must have the following properties:

- Flame-resistant
- Insulating and dry
- Covers the whole body, is undamaged and in good condition
- Safety helmet
- Trousers with no turn-ups

Protective clothing refers to a variety of different items. Operators should:

- Protect eyes and face from UV rays, heat and sparks using a protective visor and regulation filter
 - Wear regulation protective goggles with side protection behind the protective visor
 - Wear stout footwear that provides insulation even in wet conditions
 - Protect the hands with suitable gloves (electrically insulated and providing protection against heat)
 - Wear ear protection to reduce the harmful effects of noise and to prevent injury
-

Keep all persons, especially children, out of the working area while any devices are in operation or welding is in progress. If, however, there are people in the vicinity:

- Make them aware of all the dangers (risk of dazzling by the arc, injury from flying sparks, harmful welding fumes, noise, possible risks from mains current and welding current, etc.)
- Provide suitable protective equipment
- Alternatively, erect suitable safety screens/curtains.

Noise emission values

The device generates a maximum sound power level of <80 dB(A) (ref. 1pW) when idling and in the cooling phase following operation at the maximum permissible operating point under maximum rated load conditions according to EN 60974-1.

It is not possible to provide a workplace-related emission value during welding (or cutting) as this is influenced by both the process and the environment. All manner of different welding parameters come into play, including the welding process (MIG/MAG, TIG welding), the type of power selected (DC or AC), the power range, the type of weld metal, the resonance characteristics of the workpiece, the workplace environment, etc.

Danger from toxic gases and vapours

The fumes produced during welding contain harmful gases and vapours.

Welding fumes contain substances that cause cancer, as stated in Monograph 118 of the International Agency for Research on Cancer.

Use at-source extraction and a room extraction system.
If necessary, use a welding torch with an integrated extraction device.

Keep your face away from welding fumes and gases.

Fumes and hazardous gases

- must not be breathed in
- must be extracted from the working area using appropriate methods.

Ensure an adequate supply of fresh air. Ensure that there is a ventilation rate of at least 20 m³ per hour at all times.

Otherwise, a welding helmet with an air supply must be worn.

If there is any doubt about whether the extraction capacity is sufficient, the measured toxic emission values should be compared with the permissible limit values.

The following components are responsible, amongst other things, for the degree of toxicity of welding fumes:

- Metals used for the workpiece
- Electrodes
- Coatings
- Cleaners, degreasers, etc.
- Welding process used

The relevant material safety data sheets and manufacturer's specifications for the listed components should therefore be studied carefully.

Recommendations for trade fair scenarios, risk management measures and for identifying working conditions can be found on the European Welding Association website under Health & Safety (<https://european-welding.org>).

Flammable vapours (e.g. solvent fumes) should be kept away from the arc's radiation area.

Close the shielding gas cylinder valve or main gas supply if no welding is taking place.

Danger from flying sparks

Flying sparks may cause fires or explosions.

Never weld close to flammable materials.

Flammable materials must be at least 11 metres (36 ft. 1.07 in.) away from the arc, or alternatively covered with an approved cover.

A suitable, tested fire extinguisher must be available and ready for use.

Sparks and pieces of hot metal may also get into adjacent areas through small gaps or openings. Take appropriate precautions to prevent any danger of injury or fire.

Welding must not be performed in areas that are subject to fire or explosion or near sealed tanks, vessels or pipes unless these have been prepared in accordance with the relevant national and international standards.

Do not carry out welding on containers that are being or have been used to store gases, propellants, mineral oils or similar products. Residues pose an explosive hazard.

Risks from mains current and welding current

An electric shock is potentially life threatening and can be fatal.

Do not touch live parts either inside or outside the device.

During MIG/MAG welding and TIG welding, the welding wire, the wire spool, the feed rollers and all pieces of metal that are in contact with the welding wire are live.

Always set the wirefeeder up on a sufficiently insulated surface or use a suitable, insulated wirefeeder holder.

Make sure that you and others are protected with an adequately insulated, dry base or cover for the earth or ground potential. This base or cover must extend over the entire area between the body and the earth or ground potential.

All cables and leads must be secured, undamaged, insulated and adequately dimensioned. Replace loose connections and scorched, damaged, or inadequately dimensioned cables and leads immediately.

Use the handle to ensure the power connections are tight before every use.

In the case of power cables with a bayonet connector, rotate the power cable around the longitudinal axis by at least 180° and pretension.

Do not wrap cables or leads around the body or parts of the body.

The electrode (rod electrode, tungsten electrode, welding wire, etc.) must

- never be immersed in liquid for cooling
 - never be touched when the welding system is switched on.
-

Double the open circuit voltage of a welding system can occur between the welding electrodes of two welding systems. Touching the potentials of both electrodes at the same time may be fatal under certain circumstances.

Arrange for the mains cable to be checked regularly by a qualified electrician to ensure the ground conductor is functioning properly.

Protection class I devices require a mains supply with ground conductor and a connector system with ground conductor contact for proper operation.

Operation of the device on a mains supply without ground conductor and on a socket without ground conductor contact is only permitted if all national regulations for protective separation are observed.

Otherwise, this is considered gross negligence. The manufacturer shall not be held liable for any damage arising from such usage.

If necessary, provide adequate earthing for the workpiece.

Switch off unused devices.

Wear a safety harness if working at height.

Before working on the device, switch it off and pull out the mains plug.

Attach a clearly legible and easy-to-understand warning sign to the device to prevent anyone from plugging the mains plug back in and switching it on again.

After opening the device:

- Discharge all live components
 - Ensure that all components in the device are de-energised.
-

If work on live parts is required, have a second person switch off the main switch at the right moment.

Meandering welding currents

If the following instructions are ignored, meandering welding currents can develop with the following consequences:

- Fire hazard
 - Overheating of parts connected to the workpiece
 - Damage to ground conductors
 - Damage to device and other electrical equipment
-

Ensure that the workpiece is held securely by the workpiece clamp.

Attach the workpiece clamp as close as possible to the area that is to be welded.

Position the device with sufficient insulation against electrically conductive environments, such as insulation against conductive floor or insulation to conductive racks.

If power distribution boards, twin-head mounts, etc., are being used, note the following: The electrode of the welding torch / electrode holder that is not used is also live. Make sure that the welding torch / electrode holder that is not used is kept sufficiently insulated.

In the case of automated MIG/MAG applications, ensure that only an insulated wire electrode is routed from the welding wire drum, large wirefeeder spool or wirespool to the wirefeeder.

EMC Device Classifications

Devices in emission class A:

- Are only designed for use in industrial settings
 - Can cause line-bound and radiated interference in other areas
-

Devices in emission class B:

- Satisfy the emissions criteria for residential and industrial areas. This is also true for residential areas in which the energy is supplied from the public low-voltage mains.
-

EMC device classification as per the rating plate or technical data.

EMC measures

In certain cases, even though a device complies with the standard limit values for emissions, it may affect the application area for which it was designed (e.g. when there is sensitive equipment at the same location, or if the site where the device is installed is close to either radio or television receivers).

If this is the case, then the operator is obliged to take appropriate action to rectify the situation.

Check and evaluate the immunity to interference of nearby devices according to national and international regulations. Examples of equipment that may be susceptible to interference from the device include:

- Safety devices
 - Network, signal and data transfer lines
 - IT and telecommunications devices
 - Measuring and calibrating devices
-

Supporting measures for avoidance of EMC problems:

1. Mains supply
 - If electromagnetic interference arises despite the correct mains connection, additional measures are necessary (e.g. use of a suitable line filter)
 2. Welding power-leads
 - must be kept as short as possible
 - must be laid close together (to avoid EMF problems)
 - must be kept well apart from other leads
 3. Equipotential bonding
 4. Earthing of the workpiece
 - If necessary, establish an earth connection using suitable capacitors.
 5. Shield, if necessary
 - Shield other devices nearby
 - Shield the entire welding installation
-

EMF measures

Electromagnetic fields may pose as yet unknown risks to health:

- Effects on the health of persons in the vicinity, e.g. those with pacemakers and hearing aids
 - Individuals with pacemakers must seek advice from their doctor before approaching the device or any welding that is in progress
 - For safety reasons, maintain as large a distance as possible between the welding power-leads and the head/torso of the welder
 - Do not carry welding power-leads and hosepacks over the shoulders or wind them around any part of the body
-

Specific hazards

Keep hands, hair, clothing and tools away from moving parts. For example:

- Fans
 - Cogs
 - Rollers
 - Shafts
 - Wire spools and welding wires
-

Do not reach into the rotating cogs of the wire drive or into rotating drive components.

Covers and side panels must only be opened/removed while maintenance or repair work is being carried out.

During operation

- Ensure that all covers are closed and all side panels are fitted properly.
- Keep all covers and side panels closed.

Welding wire emerging from the welding torch poses a high risk of injury (piercing of the hand, injuries to the face and eyes, etc.)

Therefore, always keep the welding torch away from the body (devices with wirefeeder) and wear suitable protective goggles.

Never touch the workpiece during or after welding - risk of burns.

Slag can jump off cooling workpieces. The specified protective equipment must therefore also be worn when reworking workpieces, and steps must be taken to ensure that other people are also adequately protected.

Welding torches and other parts with a high operating temperature must be allowed to cool down before handling.

Special provisions apply in areas at risk of fire or explosion

- observe relevant national and international regulations.

Welding systems for work in areas with increased electrical risk (e.g. near boilers) must carry the 'Safety' sign. However, the welding system must not be located in such areas.

Risk of scalding from escaping coolant. Switch off cooling unit before disconnecting coolant flow or return lines.

Observe the information on the coolant safety data sheet when handling coolant. The coolant safety data sheet may be obtained from your service centre or downloaded from the manufacturer's website.

Use only suitable load-carrying equipment supplied by the manufacturer when transporting devices by crane.

- Hook chains or ropes onto all suspension points provided on the load-carrying equipment.
 - Chains and ropes must be at the smallest angle possible to the vertical.
 - Remove gas cylinder and wirefeeder (MIG/MAG and TIG devices).
-

If the wirefeeder is attached to a crane holder during welding, always use a suitable, insulated wirefeeder hoisting attachment (MIG/MAG and TIG devices).

If the device has a carrying strap or handle, this is intended solely for carrying by hand. The carrying strap is not to be used if transporting with a crane, counter-balanced lift truck or other mechanical hoist.

All lifting tackle (straps, handles, chains, etc.) used in connection with the device or its components must be tested regularly (e.g. for mechanical damage, corrosion or changes caused by other environmental factors).

The testing interval and scope of testing must comply with applicable national standards and directives as a minimum.

Odourless and colourless shielding gas may escape unnoticed if an adapter is used for the shielding gas connection. Prior to assembly, seal the device-side thread of the adapter for the shielding gas connection using suitable Teflon tape.

Requirement for the shielding gas

Especially with ring lines, contaminated shielding gas can cause damage to equipment and reduce welding quality.

Meet the following requirements regarding shielding gas quality:

- Solid particle size < 40 µm
- Pressure condensation point < -20 °C
- Max. oil content < 25 mg/m³

Use filters if necessary.

Danger from shielding gas cylinders

Shielding gas cylinders contain gas under pressure and can explode if damaged. As the shielding gas cylinders are part of the welding equipment, they must be handled with the greatest of care.

Protect shielding gas cylinders containing compressed gas from excessive heat, mechanical impact, slag, naked flames, sparks and arcs.

Mount the shielding gas cylinders vertically and secure according to instructions to prevent them falling over.

Keep the shielding gas cylinders well away from any welding or other electrical circuits.

Never hang a welding torch on a shielding gas cylinder.

Never touch a shielding gas cylinder with an electrode.

Risk of explosion - never attempt to weld a pressurised shielding gas cylinder.

Only use shielding gas cylinders suitable for the application in hand, along with the correct and appropriate accessories (regulator, hoses and fittings). Only use shielding gas cylinders and accessories that are in good condition.

Turn your face to one side when opening the valve of a shielding gas cylinder.

Close the shielding gas cylinder valve if no welding is taking place.

If the shielding gas cylinder is not connected, leave the valve cap in place on the cylinder.

The manufacturer's instructions must be observed as well as applicable national and international regulations for shielding gas cylinders and accessories.

Safety measures at the installation location and during transport

A device toppling over could easily kill someone. Place the device on a solid, level surface such that it remains stable

- The maximum permissible tilt angle is 10°.

Special regulations apply in rooms at risk of fire or explosion

- Observe relevant national and international regulations.

Use internal directives and checks to ensure that the workplace environment is always clean and clearly laid out.

Only set up and operate the device in accordance with the degree of protection shown on the rating plate.

When setting up the device, ensure there is an all-round clearance of 0.5 m (1 ft. 7.69 in.) to ensure that cooling air can flow in and out freely.

When transporting the device, observe the relevant national and local guidelines and accident prevention regulations. This applies especially to guidelines regarding the risks arising during transport.

Do not lift or transport operational devices. Switch off devices before transport or lifting.

Before transporting the device, allow coolant to drain completely and detach the following components:

- Wirefeeder
- Wirespool
- Shielding gas cylinder

After transporting the device, the device must be visually inspected for damage before commissioning. Any damage must be repaired by trained service technicians before commissioning the device.

Safety measures in normal operation

Only operate the device when all safety devices are fully functional. If the safety devices are not fully functional, there is a risk of

- injury or death to the operator or a third party
- damage to the device and other material assets belonging to the operator
- inefficient operation of the device

Any safety devices that are not functioning properly must be repaired before switching on the device.

Never bypass or disable safety devices.

Before switching on the device, ensure that no one is likely to be endangered.

Check the device at least once a week for obvious damage and proper functioning of safety devices.

Always fasten the shielding gas cylinder securely and remove it beforehand if the device is to be transported by crane.

Only the manufacturer's original coolant is suitable for use with our devices due to its properties (electrical conductivity, anti-freeze agent, material compatibility, flammability, etc.).

Only use suitable original coolant from the manufacturer.

Do not mix the manufacturer's original coolant with other coolants.

Only connect the manufacturer's system components to the cooling circuit.

The manufacturer accepts no liability for damage resulting from use of other system components or a different coolant. In addition, all warranty claims will be forfeited.

Cooling Liquid FCL 10/20 does not ignite. The ethanol-based coolant can ignite under certain conditions. Transport the coolant only in its original, sealed containers and keep well away from any sources of ignition.

Used coolant must be disposed of properly in accordance with the relevant national and international regulations. The coolant safety data sheet may be obtained from your service centre or downloaded from the manufacturer's website.

Check the coolant level before starting to weld, while the system is still cool.

Commissioning, maintenance and repair

It is impossible to guarantee that bought-in parts are designed and manufactured to meet the demands made of them, or that they satisfy safety requirements.

- Use only original spare and wearing parts (also applies to standard parts).
- Do not carry out any modifications, alterations, etc. to the device without the manufacturer's consent.
- Components that are not in perfect condition must be replaced immediately.
- When ordering, please give the exact designation and part number as shown in the spare parts list, as well as the serial number of your device.

The housing screws provide the ground conductor connection for earthing the housing parts.

Only use original housing screws in the correct number and tightened to the specified torque.

Safety inspection

The manufacturer recommends that a safety inspection of the device be performed at least once every 12 months.

The manufacturer recommends that the welding system be calibrated during the same 12-month period.

A safety inspection should be carried out by a qualified electrician

- after any changes are made
- after any additional parts are installed, or after any conversions
- after repair, care and maintenance are carried out
- at least every twelve months.

For safety inspections, follow the appropriate national and international standards and directives.

Further details on safety inspection and calibration can be obtained from your service centre. They will provide you with any documents you may require, on request.

Disposal

Waste electrical and electronic equipment must be collected separately and recycled in an environmentally responsible manner in accordance with the EU Directive and national law. Used equipment must be returned to the distributor or through a local, authorised collection and disposal system. Proper disposal of the old device promotes sustainable recycling of material resources. Ignoring this may lead to potential health/environmental impacts.

Packaging materials

Collected separately. Check your municipality's regulations. Reduce the volume of the box.

Safety symbols

Devices with the CE mark satisfy the essential requirements of the low-voltage and electromagnetic compatibility directives (e.g. relevant product standards of the EN 60 974 series).

Fronius International GmbH hereby declares that the device is compliant with Directive 2014/53/EU. The full text on the EU Declaration of Conformity can be found at the following address: <http://www.fronius.com>

Devices marked with the CSA test mark satisfy the requirements of the relevant standards for Canada and the USA.

Data protection The user is responsible for the safekeeping of any changes made to the factory settings. The manufacturer accepts no liability for any deleted personal settings.

Copyright Copyright of these operating instructions remains with the manufacturer.

The text and illustrations are all technically correct at the time of printing. We reserve the right to make changes. The contents of the operating instructions shall not provide the basis for any claims whatsoever on the part of the purchaser. If you have any suggestions for improvement, or can point out any mistakes that you have found in the instructions, we will be most grateful for your comments.

General

Device concept

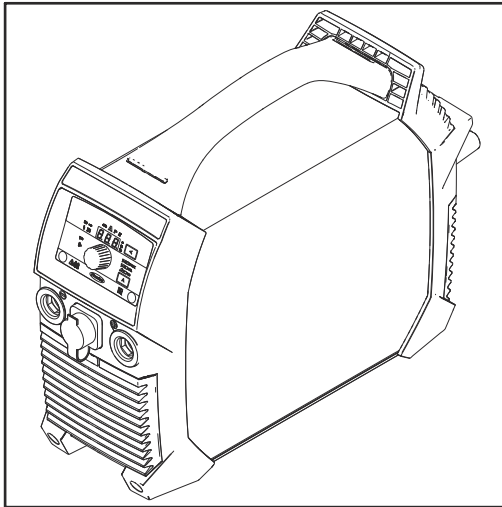

The welding system has the following properties:

- Compact dimensions
- Robust plastic housing
- Extremely reliable even under harsh operating conditions
- Carrying strap for easy transport on construction sites, etc.
- Protected controls
- Current sockets with bayonet latch

In conjunction with the digital resonance inverter, an electronic regulator adapts the welding system characteristic to suit the welding electrode during welding. The result is a lightweight and compact device with excellent ignition and weld properties.

The welding system also features a 'Power Factor Correction', which adapts the current consumption of the welding system to the sinusoidal mains voltage. This results in numerous advantages for the user, such as:

- Low primary current
- Low conduction losses
- Late tripping of the automatic circuit breaker
- Improved stability in the event of voltage fluctuations
- Long mains leads can be used
- In the case of multivoltage devices, a continuous input voltage range.

When using cellulose electrodes (CEL), a dedicated operating mode can be chosen for perfect welding results.

TIG welding with touchdown ignition greatly extends the range of applications.

Warning notices on the device

The warning notices and safety symbols on the welding system must not be removed or painted over. They warn against incorrect operation which can lead to serious injury and damage.

Meaning of safety symbols on the device:



Welding is dangerous. The following basic requirements must be met to ensure the equipment is used properly:

- Welders must be sufficiently qualified
- Suitable protective equipment must be used
- All persons not involved must be kept at a safe distance from the welding process



Do not use the functions described here until you have fully read and understood the following documents:

- These Operating Instructions
- All the Operating Instructions for the system components of the welding system, especially the safety rules



Do not dispose of used devices with domestic waste. Dispose of them according to the safety rules.

⚠ WARNING	⚠ AVERTISSEMENT
<p>Do Not Remove, Destroy, or Cover This Label</p> <p>PROTECT yourself and others. ARC PROCESSES can be hazardous.</p> <ul style="list-style-type: none"> • Before use, read and follow all labels, the manufacturer's instruction manual, employer's safety practices, and Material Safety Data Sheets (MSDSs). • Only qualified persons are to install, use, or service this equipment. • Flammable vapors keep away. • Damaged or modified batteries may exhibit unpredictable behaviour resulting in fire, explosion or risk of injury. 	<p>Ne pas retirer, détruire ni couvrir cette étiquette</p> <p>SE PROTÉGER et protéger les autres. Les PROCÉDÉS À L'ARC ÉLECTRIQUE peuvent être dangereux.</p> <ul style="list-style-type: none"> • Avant utilisation, lire et respecter l'ensemble des étiquettes, les instructions de service du fabricant, les pratiques de sécurité de l'employeur et les fiches techniques de sécurité du matériau. • Seules des personnes qualifiées sont autorisées à installer, utiliser ou assurer l'entretien de cet équipement. • Les personnes portant un stimulateur cardiaque doivent rester à l'écart. • Les batteries endommagées ou modifiées peuvent avoir un comportement imprévisible susceptible de provoquer un incendie, une explosion ou un risque de blessure.
<p>ELECTRIC SHOCK can kill.</p> <ul style="list-style-type: none"> • Do not touch live electrical parts. • Always wear dry insulating gloves. • Insulate yourself from work and ground. • Disconnect input power before servicing unit. • Welding wire and drive parts may be at welding voltage. 	<p>Les DÉCHARGES ÉLECTRIQUES peuvent être mortelles.</p> <ul style="list-style-type: none"> • Ne pas toucher les composants électriques sous tension. • Toujours porter des gants isolants secs. • S'éloier de la zone de travail et de la terre. • Déconnecter l'alimentation d'entrée avant de procéder à l'entretien de l'unité. • Le fil d'apport et les composants d'entraînement peuvent être porteurs de la tension de soudage.
<p>FUMES AND GASES can be hazardous to your health.</p> <ul style="list-style-type: none"> • Keep your head out of the fumes. • Use enough ventilation, exhaust at the arc, or both to keep fumes and gases from your breathing zone and the general area. • Under abusive conditions, liquid may be ejected from the battery; avoid contact. 	<p>Les FUMÉES ET GAZ peuvent être nocifs pour la santé.</p> <ul style="list-style-type: none"> • Garder la tête à l'écart des fumées. • Utiliser une ventilation suffisante, un échappement au niveau de l'arc électrique, voire les deux pour maintenir les fumées et les gaz à l'écart de la zone de respiration et de la zone générale. • En cas d'utilisation abusive, du liquide peut être éjecté de la batterie; éviter tout contact.
<p>SPARKS AND SPATTER can cause fire or explosion.</p> <ul style="list-style-type: none"> • Do not use near flammable material. • Do not use on closed containers. 	<p>La FORMATION DE PROJECTIONS ET D'ÉTINCELLES peut provoquer un incendie ou une explosion.</p> <ul style="list-style-type: none"> • Ne pas utiliser à proximité d'un matériau inflammable. • Ne pas utiliser sur des contenants fermés.
<p>ARC RAYS can injure eyes and burn skin. NOISE can damage hearing.</p> <ul style="list-style-type: none"> • Wear correct eye, ear, and body protection. 	<p>Les RAYONS D'ARC ÉLECTRIQUE peuvent provoquer des blessures oculaires et des brûlures. Le BRUIT peut endommager l'ouïe.</p> <ul style="list-style-type: none"> • Porter une protection oculaire, auditive et corporelle adaptée.

AR-TN: 42.0409.1374
Spez. Dat.: 2023-05-31

42.0409.1374
See American National Standard Z49.1, Safety in Welding, Cutting, and Allied Processes, and use appropriate personal protective equipment. The user must read and understand the instructions, warnings, and safety rules. © 2023 Miller Electric Mfg. Co. All rights reserved. Miller Electric Mfg. Co. is a registered trademark of Miller Electric Mfg. Co. in the USA, and in other countries. Miller Electric Mfg. Co. is not responsible for any damage or injury caused by the use of this equipment. The device complies with Part 15 of the FCC Rules. Operation is subject to the condition that any interference that may be caused by this device must be accepted by the user. Miller Electric Mfg. Co. is not responsible for any damage or injury caused by the use of this equipment.

Application areas

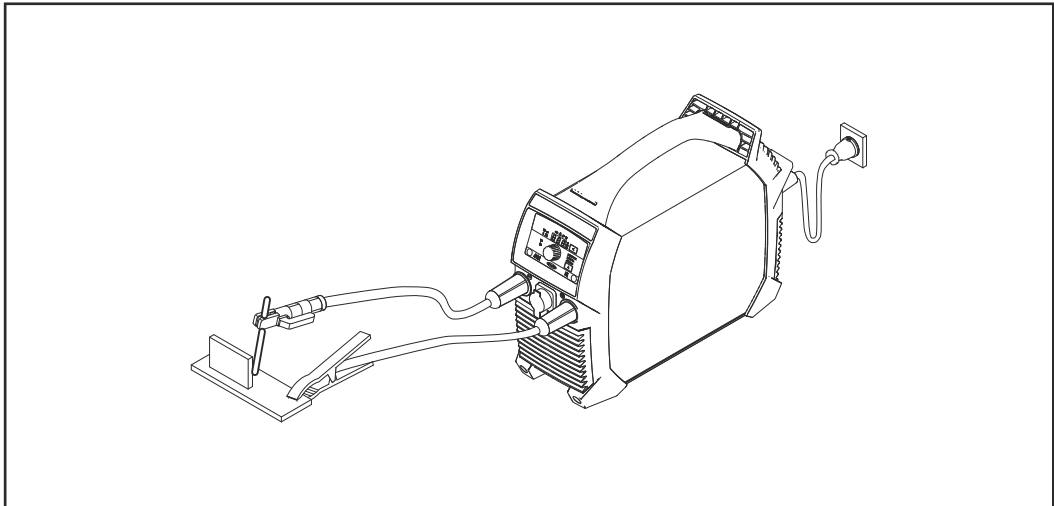

MMA welding

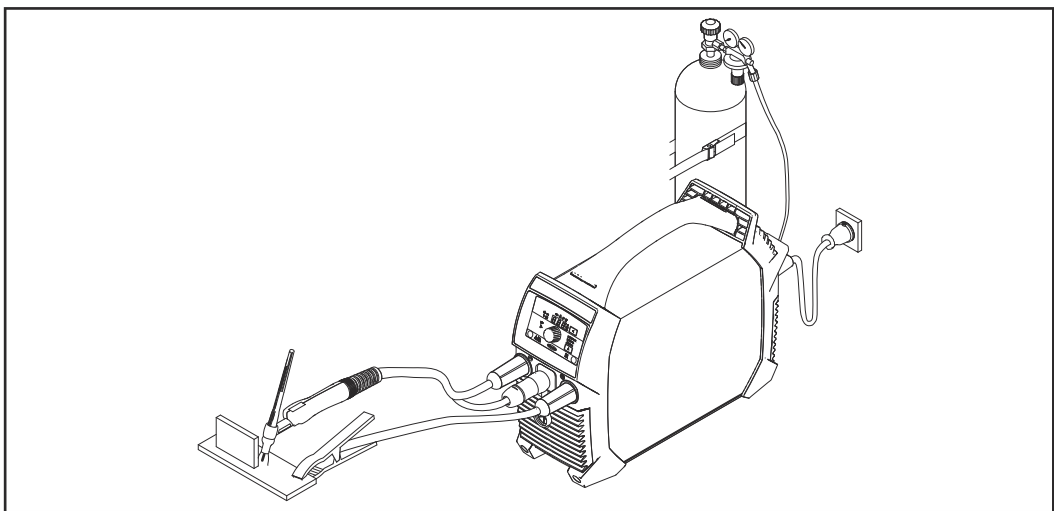

TIG welding, welding torch with torch trigger and TIG Multi Connector plug

Before commissioning

Safety

WARNING!

Danger from incorrect operation and work that is not carried out properly.

This can result in serious personal injury and damage to property.

- ▶ All the work and functions described in this document must only be carried out by technically trained and qualified personnel.
 - ▶ Read and understand this document in full.
 - ▶ Read and understand all safety rules and user documentation for this device and all system components.
-

Intended use

The welding system is intended exclusively for MMA welding and TIG welding in conjunction with system components from the manufacturer.

Utilisation for any other purpose, or in any other manner, shall be deemed to be not in accordance with the intended purpose.

The manufacturer shall not be held liable for any damages arising from such usage.

Proper use also includes:

- Carefully reading these Operating Instructions
 - Following all the instructions and safety rules in these Operating Instructions
 - Performing all stipulated inspection and maintenance work
-

Setup regulations

WARNING!

Danger from machines toppling over or falling.

This can result in serious personal injury and damage to property.

- ▶ Set up the device securely on an even, solid surface.
 - ▶ Check all screw connections are tightly fastened after installation.
-

The device is tested to IP 23 protection, meaning:

- Protection against penetration by solid foreign bodies with diameters > 12.5 mm (0.49 in.)
- Protected against spraywater at any angle up to 60° to the vertical

Cooling air

The device must be set up in such a way that cooling air can flow freely through the slots in the front and rear panels.

Dust

Ensure that metallic dust is not sucked into the system by the fan, when carrying out grinding for example.

Outdoor operation

The device can be set up and operated outdoors in accordance with IP23 degree of protection. Avoid direct wetting (e.g. from rain).

**Generator-
powered opera-
tion**

The welding system is generator-compatible.

In order to dimension the required generator output, the maximum apparent power $S_{1\max}$ of the welding system is required.

The maximum apparent power $S_{1\max}$ of the welding system can be calculated as follows:

$$S_{1\max} = I_{1\max} \times U_1$$

See device rating plate or technical data for $I_{1\max}$ and U_1 values

The generator apparent power S_{GEN} needed is calculated using the following rule of thumb:

$$S_{\text{GEN}} = S_{1\max} \times 1.35$$

A smaller generator may be used when not welding at full power.

IMPORTANT! The generator apparent power S_{GEN} must always be higher than the maximum apparent power $S_{1\max}$ of the welding system.

When using single-phase devices with a 3-phase generator, note that the specified generator apparent power is often only available as a whole across all three phases of the generator. If necessary, obtain further information on the single-phase power of the generator from the generator manufacturer.

NOTE!

The voltage delivered by the generator must never exceed the upper or lower limits of the mains voltage tolerance range.

Details of the mains voltage tolerance can be found in the 'Technical data' section.

Controls, connections and mechanical components

Safety



WARNING!

Danger from incorrect operation and work that is not carried out properly.

This can result in serious personal injury and damage to property.

- ▶ All the work and functions described in this document must only be carried out by technically trained and qualified personnel.
 - ▶ Read and understand this document in full.
 - ▶ Read and understand all safety rules and user documentation for this device and all system components.
-

As a result of software updates, you may find that there are functions available on your device that are not described in these Operating Instructions, or vice versa.

Certain illustrations may also differ slightly from the actual controls on your device, but these controls function in exactly the same way.

Ignis 150 controls, connections and mechanical components

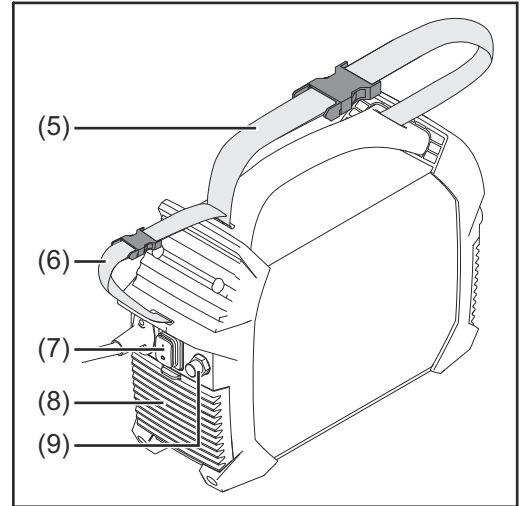
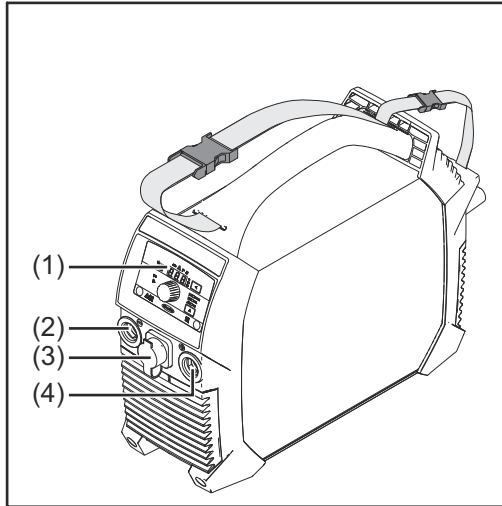

(1) Control panel

(2) (-) current socket
with bayonet latch

(3) TIG Multi Connector

After connecting a remote control to the welding system

- 'rc' appears on the welding system display
- the welding current can only be adjusted using the remote control

(4) (+) current socket
with bayonet latch

(5) Carrying strap

(6) Cable strap
for holding the mains cable and the welding power-leads
Do not use to move the device!

(7) Mains switch

(8) Air filter

(9) Shielding gas connection

Use of the current connections during manual metal arc welding (depending on electrode type):

- **(+) current socket** for electrode holder or grounding cable
- **(-) current socket** for electrode holder or grounding cable

Use of the current connections during TIG welding:

- **(+) current socket** for grounding cable
- **(-) current socket** for welding torch

Ignis 180 controls, connections and mechanical components

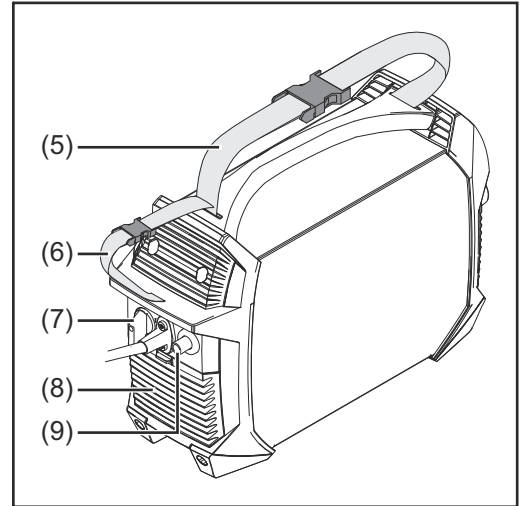
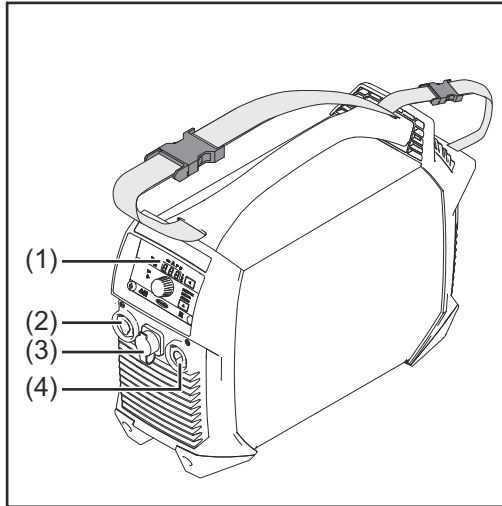

(1) Control panel

(2) (-) current socket
with bayonet latch

(3) TIG Multi Connector

After connecting a remote control to the welding system

- 'rc' appears on the welding system display
- the welding current can only be adjusted using the remote control

(4) (+) current socket
with bayonet latch

(5) Carrying strap

(6) Cable strap
for holding the mains cable and the welding power-leads
Do not use to move the device!

(7) Mains switch

(8) Air filter

(9) Shielding gas connection

Use of the current connections during manual metal arc welding (depending on electrode type):

- **(+) current socket** for electrode holder or grounding cable
- **(-) current socket** for electrode holder or grounding cable

Use of the current connections during TIG welding:



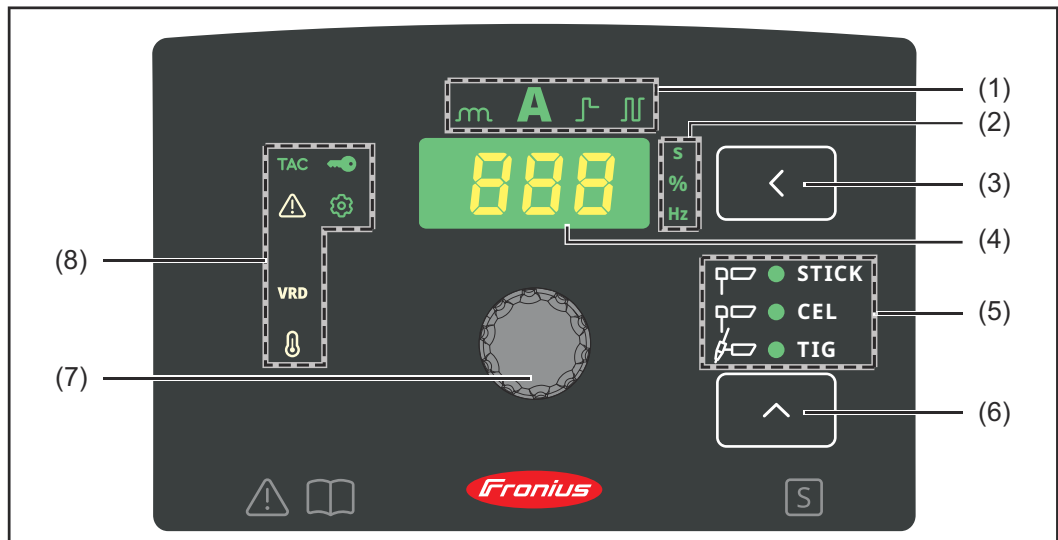

- **(+) current socket** for grounding cable
- **(-) current socket** for welding torch

Control panel





(1) Setting value indicator

shows which setting value is selected:

- Arc-force dynamic 
- Welding current 
- SoftStart / HotStart function 
- Pulse welding 

(2) Unit indicator

shows the unit of the value that is currently being changed with the adjusting dial (7):

- Time (seconds) 
- Percent 
- Frequency (Hertz) 

(3) Setting value button



for selecting the desired setting value (1)

(4) Display

shows the current figure of the selected setting value

(5) Welding process indicator

shows which welding process is selected:

- MMA welding 
- MMA welding with Cel electrode 
- TIG welding 

(6) Welding process button

for selecting the welding process

(7) Adjusting dial

for continuous adjustment of the selected setting value (1)

(8) Status indicators

display various operating modes of the welding system:

- **VRD**
lights up when the safety device for voltage reduction is activated (VRD devices only)
- **Setup**
lights up in Setup mode
- **Temperature**
lights up when the device is outside the permissible temperature range
- **Fault**
lights up in the event of a fault, also see section 'Troubleshooting'
- **TAC**
lights up when the tacking function is activated (only possible on TIG devices with the TIG welding process)



MMA welding

Preparation

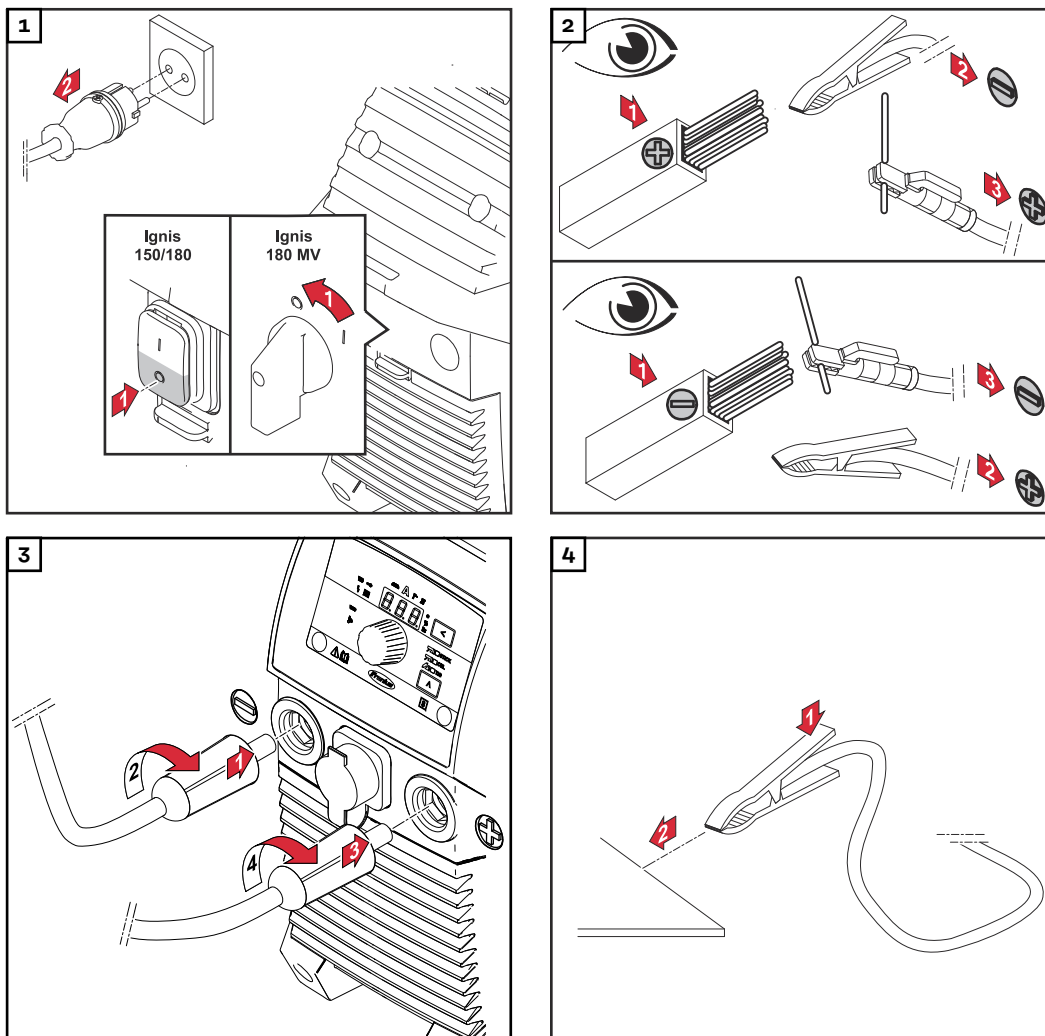

CAUTION!



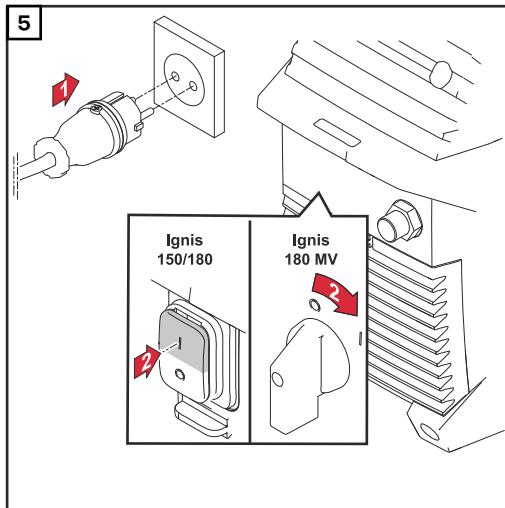

Danger from electric shocks. As soon as the welding system is switched on, the electrode in the electrode holder is live.

This can result in injury and damage to property.

- Ensure the electrode does not touch any persons or electrically conductive or earthed parts (the housing, etc.)



MMA welding

- 1** Use the welding process button to select one of the following processes:
 - MMA welding - the MMA welding indicator lights up after selection 
 - MMA welding with Cel electrode - the MMA welding with Cel electrode indicator lights up after selection 
- 2** Press the setting value button until
 - the welding current indicator lights up 
- 3** Adjust the welding current using the adjusting dial
 - Welding system is ready for welding 

SoftStart / Hot-Start function

This function is used to set the starting current.

Setting range: 1 - 200 %

Operating principle:

At the start of the welding process, the welding current is reduced (SoftStart) or increased (HotStart) for 0.5 seconds, depending on the setting.

The change is shown as a percentage from the set welding current.

The duration of the starting current can be changed in the Setup menu using the starting current duration (Hti) parameter.

Setting the starting current:

- 1** Press the setting value button until
 - the SoftStart / HotStart indicator lights up 

- 2** Turn the adjusting dial until the desired value is reached
- power source is ready for welding



The maximum HotStart current is limited as follows:

- Ignis 150 to 160 A
- Ignis 180 to 200 A

Examples (set welding current = 100 A):

100 % = 100 A starting current = function deactivated

80 % = 80 A starting current = SoftStart

135 % = 135 A starting current = HotStart

200 % = 160 A starting current on Ignis 150 = HotStart, maximum current limit is reached!

200 % = 200 A starting current on Ignis 180 = HotStart

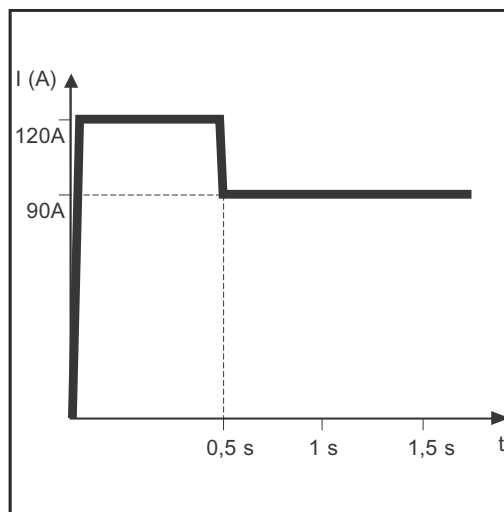

Example of HotStart function

Features of SoftStart function:

- Reduced pore formation with certain electrode types

Features of HotStart function:

- Improved ignition properties, even when using electrodes with poor ignition properties
- Better fusion of the base material during the start-up phase, meaning fewer cold-shut defects
- Largely prevents slag inclusions

Arc-force dynamic

To obtain optimum welding results, it will sometimes be necessary to adjust the arc-force dynamic.

Setting range: 0 - 100 (corresponds to 0 - 200 A current increase)

Operating principle:

At the moment of droplet transfer or in the event of a short circuit, the amperage is briefly increased in order to obtain a stable arc.

If the rod electrode is at risk of sinking into the weld pool, this measure prevents the weld pool from solidifying, as well as preventing a prolonged short-circuit of the arc. This largely prevents the rod electrode from sticking.

Setting the arc-force dynamic:

- 1** Press the setting value button until



- the arc-force dynamic indicator lights up



- 2 Turn the adjusting dial until the desired correction value is reached
- Welding system is ready for welding



The maximum arc-force dynamic current is limited as follows:

- Ignis 150 to 180 A
- Ignis 180 to 220 A

Examples:

- Arc-force dynamic = 0
 - arc-force dynamic deactivated
 - soft, low-spatter arc
- Arc-force dynamic = 20
 - arc-force dynamic with 40 A current increase
 - harder, more stable arc
- Arc-force dynamic = 60, set welding current = 100 A
 - for the Ignis 150: actual increase is just 80 A as the maximum current limit is reached!
 - for Ignis 180: arc-force dynamic with 120 A current increase

Pulse welding

Pulse welding is welding with a pulsing welding current. It is used for out-of-position welding of steel pipes or when welding thin sheets.

In these applications, the welding current set at the start of welding is not always ideal for the whole welding process:

- if the amperage is too low, the base material will not melt sufficiently
- if overheating occurs, the liquid weld pool may drip.

Setting range: 0.2 - 990 Hz

Operating principle:

- A low base current I-G rises steeply to the significantly higher pulse current I-P and drops back to the base current I-G after the Duty cycle dcY time. The pulse current I-P can be set on the welding system.
- This results in an average current that is lower than the set pulse current I-P.
- During pulse welding, small sections of the welding location melt quickly and then rapidly re-solidify.

The welding system controls the Duty cycle dcY parameter and base current I-G according to the set pulse current and pulse frequency.

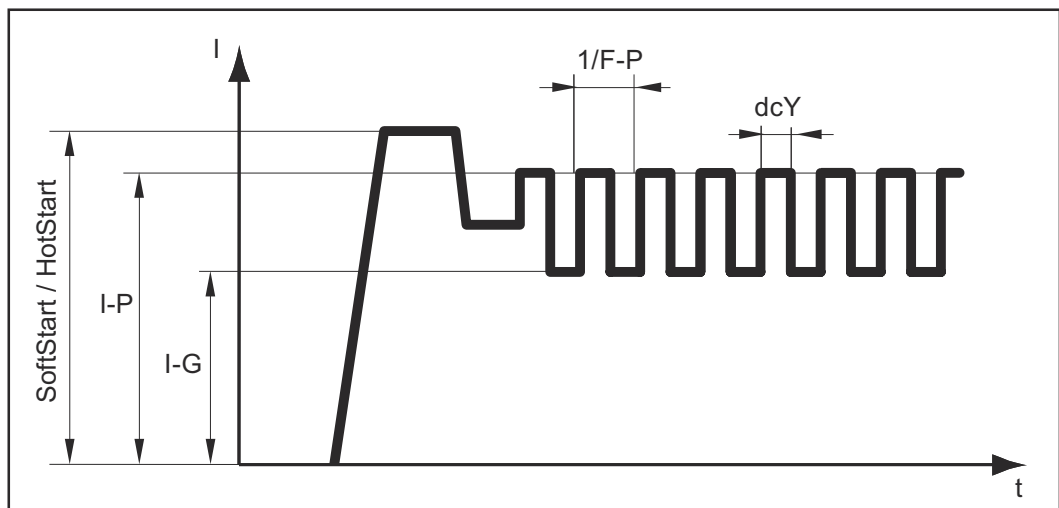

Pulse welding - welding current curve



Adjustable parameters:

- **F-P:** Pulse frequency ($1/F-P$ = time interval between two pulses)
- **I-P:** Pulse current
- SoftStart/HotStart

Fixed parameters:

- **I-G:** Base current
- **dcY:** Duty cycle

To use pulse welding:

-
- | | | |
|----------|---|---|
| 1 | Press the setting value button until |  |
| | - the pulse welding indicator lights up |  |
-
- | | | |
|----------|---|---|
| 2 | Turn the adjusting dial until the desired frequency value (Hz) is reached |  |
| | - Welding system is ready for welding | |
-

TIG modes

Symbols and their explanations

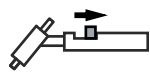

Pull back and hold the torch trigger

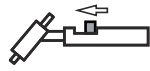

Release the torch trigger forwards



Push forward and hold the torch trigger

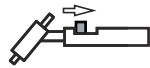

Release the torch trigger backwards

Adjustable parameters:

- **GPo:** Gas post-flow time
- **I-S:** Starting-current phase - the temperature is raised gently at low welding current, so that the filler metal can be positioned correctly
- **I-E:** Final current phase - to prevent crater cracks or cavitations
- **I-1:** Main current phase (welding-current phase) - uniform thermal input into the base material, whose temperature is raised by the continuous heat
- **I-2:** Reduced current phase - intermediate lowering of the welding current in order to prevent any local overheating of the base material

Fixed parameters:

- **GPr:** Gas pre-flow time
- **t_{up}:** UpSlope phase - the welding current is continually increased
Duration = 0.5 seconds
- **t_{down}:** DownSlope phase - the welding current is continually decreased
Duration = 0.5 seconds
- **t_S:** Starting current duration
- **t_E:** Final current duration

2-step mode

See the description [Parameters for TIG welding](#) on page 42 for details on how to activate 2-step mode.

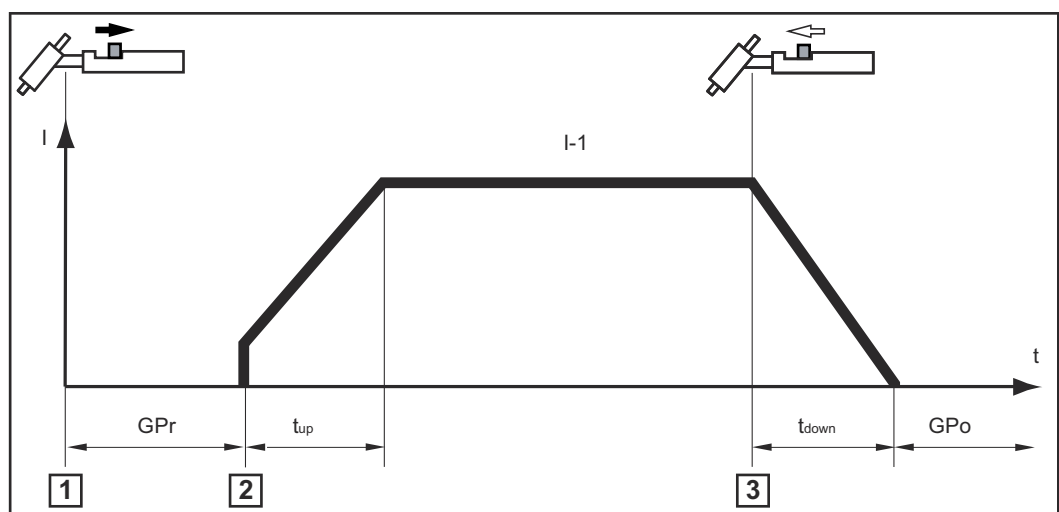

- 1** Place the tungsten electrode onto the workpiece and then pull the torch trigger back and hold => shielding gas flows

- 2 Raise the tungsten electrode => arc ignites
- 3 Release torch trigger => end of welding

4-step mode

See the description [Parameters for TIG welding](#) on page 42 for details on how to activate 4-step mode.

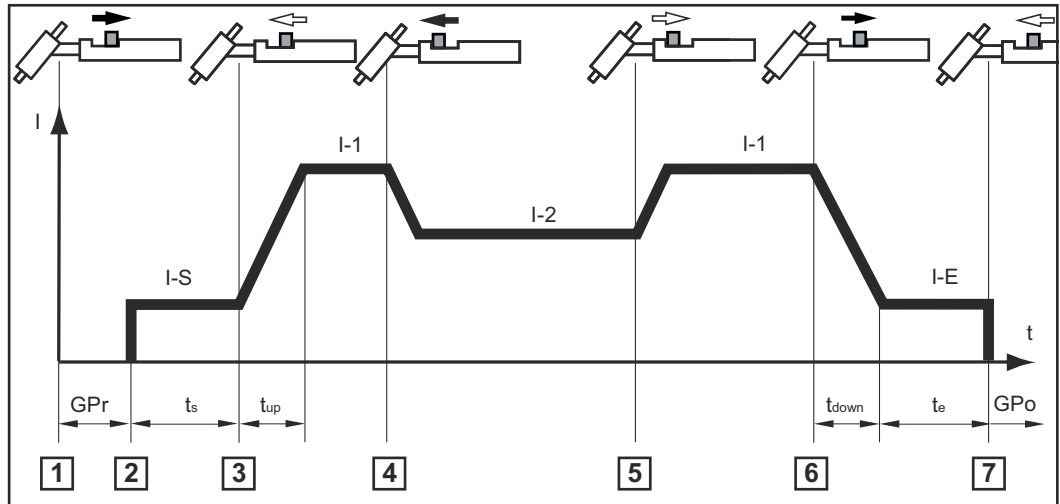

4-step mode with intermediate lowering I-2

Intermediate lowering means that the welder uses the torch trigger during the main current phase to lower the welding current to the specified reduced current I-2.

- 1 Place the tungsten electrode onto the workpiece and then pull the torch trigger back and hold => shielding gas flows
- 2 Raise the tungsten electrode => start of welding with starting current I-S
- 3 Release torch trigger => welding with main current I-1
- 4 Push forward and hold the torch trigger => activation of intermediate lowering with reduced current I-2
- 5 Release torch trigger => welding with main current I-1
- 6 Pull back and hold the torch trigger => lowering to final current I-E
- 7 Release torch trigger => end of welding

TIG welding

General

NOTE!

Do not use pure tungsten electrodes (colour-coded green) if the TIG welding process has been selected.

NOTE!

2-step and 4-step welding is only possible if a welding torch with a TIG Multi Connector plug is used.

Connecting the gas cylinder

⚠ WARNING!

Danger from falling gas cylinders.

This can result in severe personal injury and damage to property.

- ▶ Place gas cylinders on a solid, level surface so that they remain stable. Secure gas cylinders to prevent them from falling over.
- ▶ Observe the safety rules of the gas cylinder manufacturer.

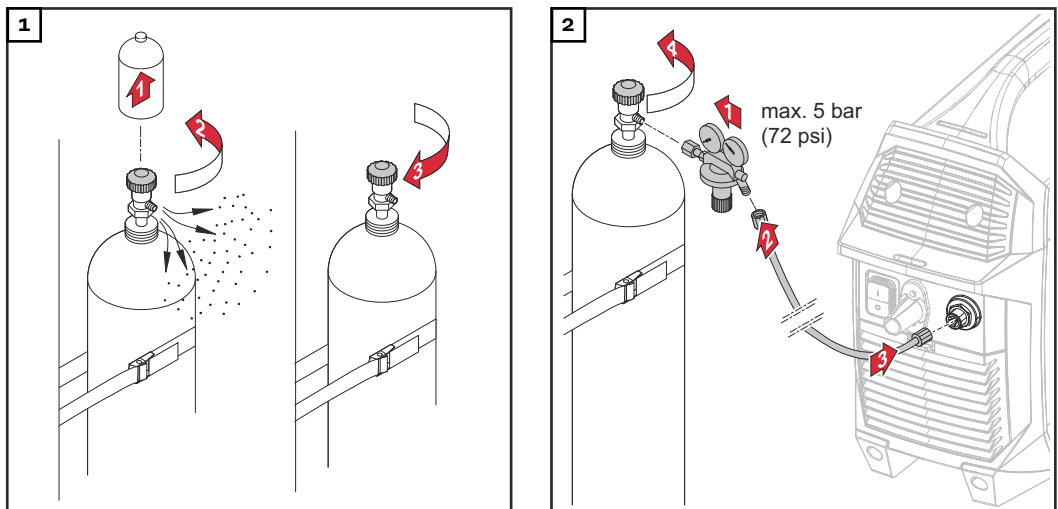

Preparation

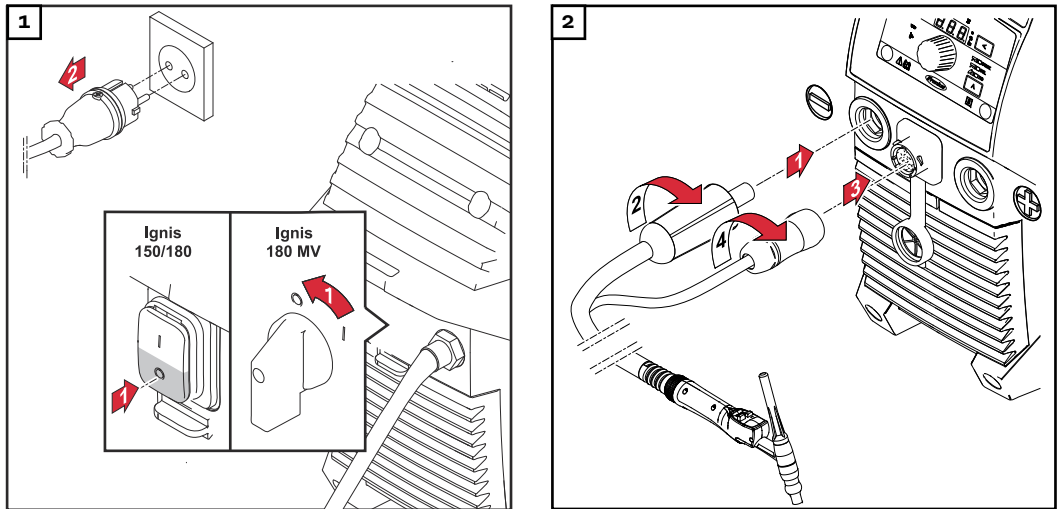

⚠ CAUTION!

Danger from electric shocks. As soon as the welding system is switched on, the electrode in the welding torch is live.

This can result in injury and damage to property.

- Ensure the electrode does not touch any persons or electrically conductive or earthed parts (the housing, etc.)

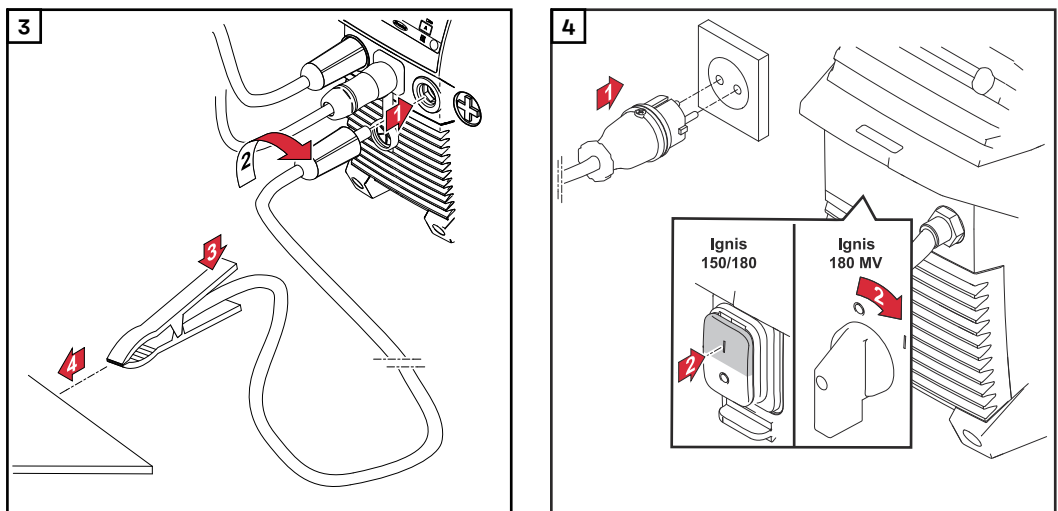

- 5** If a welding torch is used without a TIG Multi Connector plug:
In the Setup menu for the 'operating mode' (trigger mode) parameter, select the OFF setting (2-step or 4-step welding only works when a welding torch with a TIG Multi Connector plug is used)

Setting the gas pressure

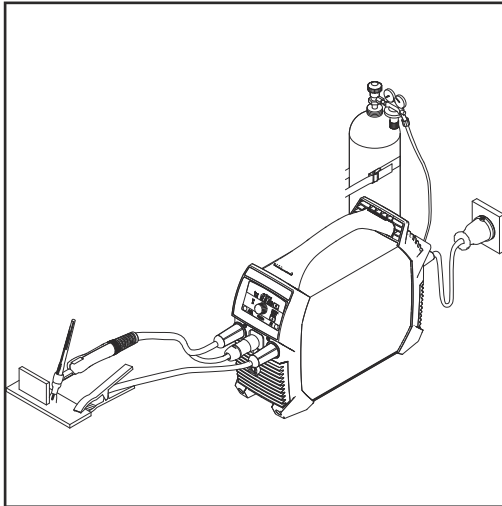





Welding torch with torch trigger (and TIG Multi Connector plug)

Welding torch with torch trigger (and TIG Multi Connector plug):

- 1 Press the torch trigger
- shielding gas flows
- 2 Set the desired gas flow rate on the pressure regulator
- 3 Release the torch trigger

TIG welding

- | | |
|---|---|
| 1 Select TIG welding with the welding process button |  |
| - the TIG welding indicator lights up |  |
| 2 Press the setting value button until |  |
| - the welding current indicator lights up |  |
| 3 Adjust the welding current using the adjusting dial |  |

When using a welding torch with a torch trigger and TIG Multi Connector plug (with 2-step mode factory setting):

- 4 Place the gas nozzle down on the ignition location, ensuring there is a gap of approx. 2 to 3 mm (5/64 to 1/8 in.) between the tungsten electrode and the workpiece
- 5 Gradually tilt the welding torch up until the tungsten electrode touches the workpiece
- 6 Pull back and hold the torch trigger
- shielding gas flows
- 7 Raise the welding torch and rotate it into its normal position
- the arc ignites
- 8 Carry out welding

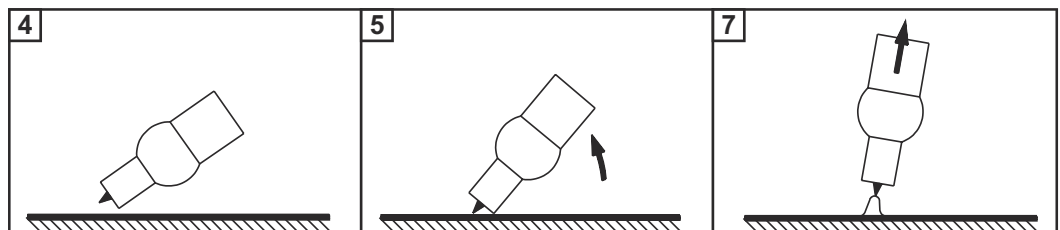

TIG Comfort Stop

To activate and set the TIG Comfort Stop function, see the description [Parameters for TIG welding](#) starting on page 42.

Operating principle and use of the TIG Comfort Stop:

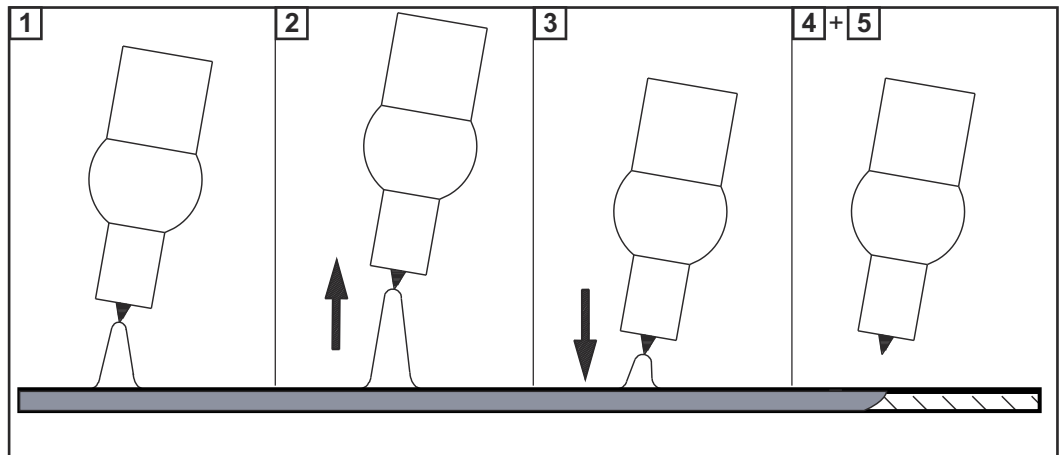

- 1** Welding
- 2** During welding, raise the welding torch
 - the arc length is increased significantly
- 3** Lower the welding torch
 - the arc length is decreased significantly
 - the TIG Comfort Stop function is activated
- 4** Keep the welding torch at the same height
 - the welding current continually decreases (DownSlope) until the arc goes out
- 5** Wait for the gas post-flow time to finish and lift the welding torch away from the workpiece

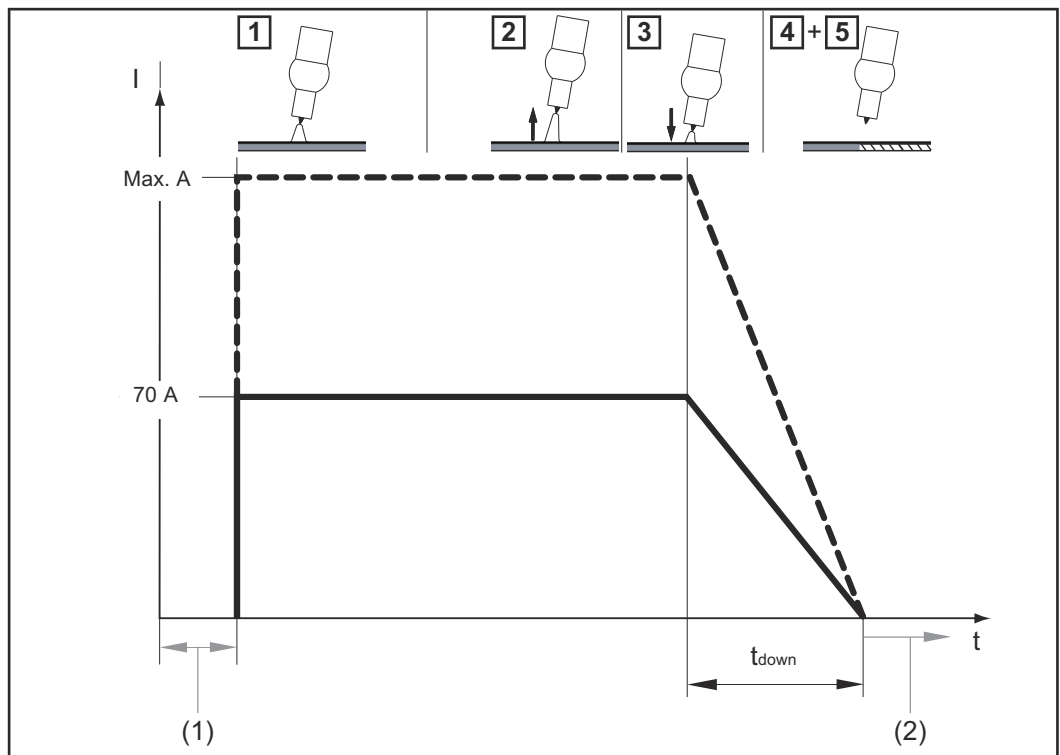

Welding current and gas flow curve with TIG Comfort Stop function activated

- (1) Gas pre-flow
- (2) Gas post-flow

DownSlope:

The DownSlope time t_{down} is 0.5 seconds and cannot be adjusted.

Gas post-flow:

The gas post-flow can be changed in the Setup menu via the "Gas post-flow time" parameter (Gas Post flow).

Pulse welding

Pulse welding is welding with a pulsing welding current. It is used for out-of-position welding of steel pipes or when welding thin sheets.

In these applications, the welding current set at the start of welding is not always ideal for the whole welding process:

- if the amperage is too low, the base material will not melt sufficiently
- if overheating occurs, the liquid weld pool may drip.

Setting range: 0.5 - 100 Hz

Operating principle:

- A low base current I-G rises steeply to the significantly higher pulse current I-P and drops back to the base current I-G after the Duty cycle dcY time.
- The pulse current I-P can be set on the welding system.
- This results in an average current that is lower than the set pulse current I-P.
- During pulse welding, small sections of the welding location melt quickly and then rapidly re-solidify.

The welding system controls the Duty cycle dcY parameter and base current I-G according to the set pulse current and pulse frequency.

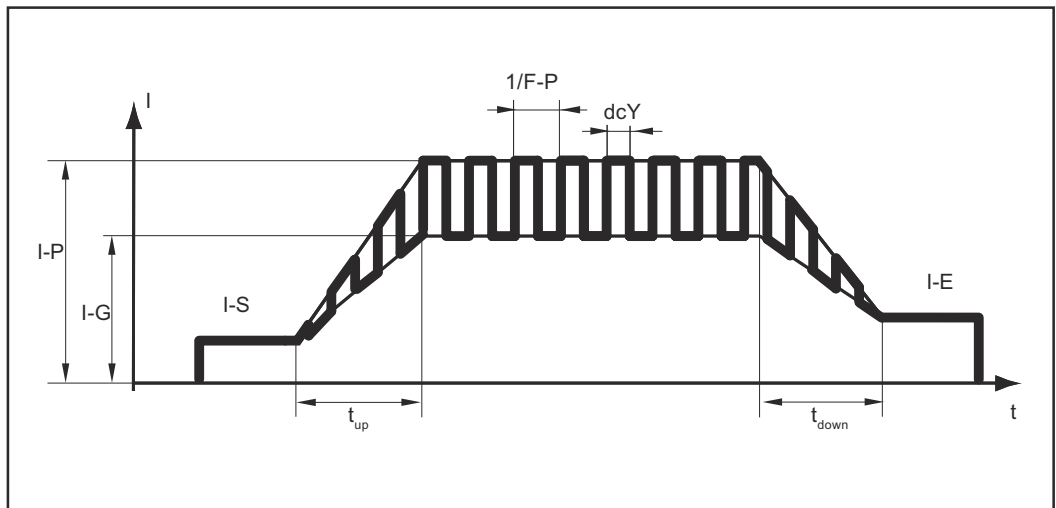

Pulse welding - welding current curve

Adjustable parameters:

- I-S = starting current
- I-E = final current
- F-P = pulse frequency ($1/F-P$ = time interval between two pulses)
- I-P = pulse current

Fixed parameters:

- t_{up} = UpSlope
- t_{Down} = DownSlope
- dcY = duty cycle
- I-G = base current

To use pulse welding:

1 Press the setting value button until



- the pulse welding indicator lights up



2 Turn the adjusting dial until the desired frequency value (Hz) is reached



- Welding system is ready for welding

Tacking function

To activate and set the tacking function, see the description [Parameters for TIG welding](#) starting on page 42.

- When a time period is specified for the tAC (tacking) setup parameter, the tacking function is assigned to all operating modes
- The basic operating sequence of each of these modes remains unchanged
- During the specified period, welding is done with a pulse current that makes the weld pool run together better when two components are being tacked.

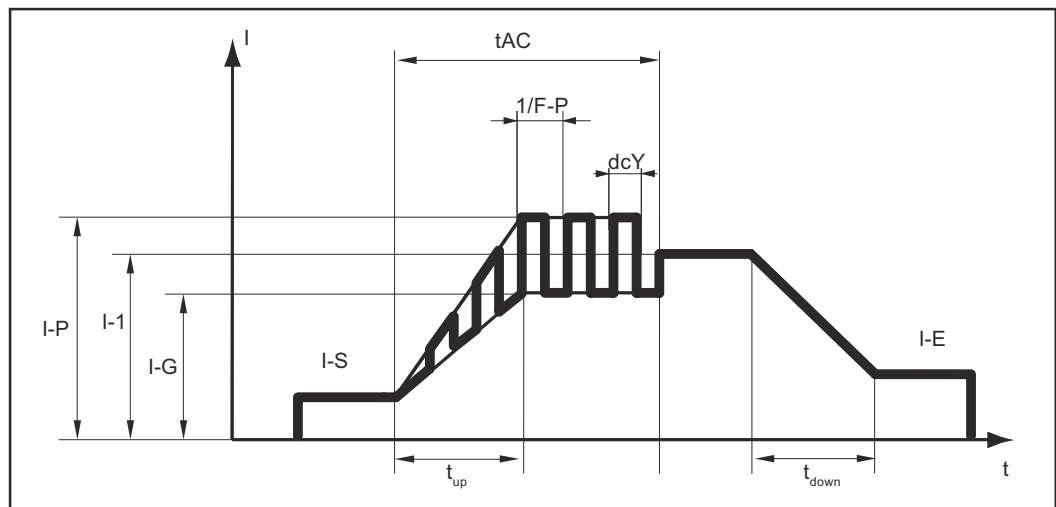

Welding current curve

Adjustable parameters:

- tAC = duration of the pulse current for the tacking process
- I-E = final current
- I-S = starting current
- I-1 = main flow

Fixed parameters:

- t_{up} = UpSlope
- t_{Down} = DownSlope
- I-P = pulse current
- dcY = duty cycle
- F-P = pulse frequency
- I-G = base current

The welding system controls the pulse frequency F-P, pulse current I-P, duty cycle dcY and base current I-G parameters according to the set main current I-1.







The pulse current starts

- after the end of the starting-current phase I-S
- with the UpSlope phase t_{up}





After the tAC time has elapsed, welding continues at a constant welding current, and any pulse parameters that may have been set are available.

Welding process Setup menu



Accessing the Setup menu

1	Use the Welding Process button to select the process whose Setup parameters are to be changed:	
	- MMA welding	
	- MMA welding with Cel electrode	
	- TIG welding	
2	Press the Setting Value and Welding Process buttons at the same time	
	- The code for the first parameter in the Setup menu is displayed on the control panel	 

Changing welding parameters

1	Turn the adjusting dial to select the required parameter	
2	Press the adjusting dial to display the preset value of the parameter	
3	Turn the adjusting dial to change the value	
	- the new value becomes effective immediately	
	- exception: when restoring the factory settings, press the adjusting dial after changing the value to activate the new value.	
4	Press the adjusting dial to return to the list of parameters	

Exiting the Setup menu

1	Press the Setting Value or Welding Process button to exit the Setup menu	 
----------	---	--

Parameters for MMA welding

Parameter	Description	Range	Unit
	Starting current duration For the SoftStart / HotStart function Factory setting: 0.5 seconds	0.1 - 2.0	Second s

Parameter	Description	Range	Unit
AST	<p>Anti-stick</p> <p>When the anti-stick function is active, the arc is extinguished after 1.5 seconds in the event of a short circuit (sticking of the electrode)</p> <p>Factory setting: ON (activated)</p>	On OFF	
Str	<p>Start ramp</p> <p>To activate/deactivate grinding mode</p> <p>Factory setting: ON (activated)</p>	On OFF	
Uco	<p>Break voltage (Voltage cut off)</p> <p>Used to specify at which arc length the welding process is to be completed. The welding voltage increases as the length of the arc increases. The arc is extinguished when it reaches the voltage specified here</p> <p>Factory setting: 45 volts</p>	25 - 90	Volts
FAC	<p>Factory setting (FACTory)</p> <p>This can be used to reset the device to its factory settings</p> <ul style="list-style-type: none"> - cancel reset - reset the parameters for the selected welding process to their factory settings - reset the parameters for all welding processes to their factory settings <p> Resetting of the selected value to its factory setting must be confirmed by pressing the adjusting dial.</p>	no YES ALL	
2nd	<p>Level 2 Setup menu</p> <p>To set general welding parameters</p> <p>For details, see the "Level 2 Setup menu" section</p>		

Parameters for
TIG welding

Parameter	Description	Range	Unit
tri	Operating mode (trigger mode)		
	- Operation using welding torch without a torch trigger	OFF	
	- 2-step mode	2t	
	- 4-step mode	4t	
	Factory setting: 2t		
1-5	Starting current (I-Start)	1 - 200	Percent
	This parameter is only available in 4-step mode (tri = 4t)		
	Factory setting: 35%		
1-2	Reduced current	1 - 200	Percent
	This parameter is only available in 4-step mode (tri = 4t)		
	Factory setting: 50%		
1-E	Final current (I-End)	1 - 100	Percent
	This parameter is only available in 4-step mode (tri = 4t)		
	Factory setting: 30%		
GPf	Gas pre-flow time (Gas Pre flow)	0.0 - 9.9	Second s
	Duration of gas pre-flow		
	Factory setting: 0.0 seconds		
GPo	Gas post-flow (Gas Post flow)	AUt 0.2 - 25	Second s
	Specified period during which gas flows at the end of welding		
	Factory setting: AUt		
GPU	Gas purging (gas purging)	0.1 - 9.9	Minutes
	Purging of the protective gas shield begins as soon as GPU is allocated a value. For safety reasons, purging of the protective gas shield cannot be restarted until a new GPU value is entered.		
	IMPORTANT! Purging the shielding gas is necessary if condensation forms when the device is left unused in a cold environment for a prolonged period. Long hosepacks are most affected.		
	Factory setting: off		

Parameter	Description	Range	Unit
C55	<p>Comfort Stop Sensitivity</p> <p>This parameter is only available when the tri parameter is set to OFF</p> <p>Factory setting: 1.5 V</p> <p>For details, see TIG Comfort Stop starting at page 36</p>	0.6 - 3.5	Volts
Uco	<p>Break voltage (Voltage cut off)</p> <p>Used to specify at which arc length the welding process is to be completed. The welding voltage increases as the length of the arc increases. The arc is extinguished when it reaches the voltage specified here.</p> <p>Factory setting: 35 volts (for 2-step mode, 4-step mode and pedal remote control)</p> <p>Factory setting: 25 V (for the trigger = OFF mode)</p>	10 - 45	Volts
tAC	<p>Tacking function (tACking)</p> <p>Factory setting: OFF</p> <p>For details, see description of the "Tacking function"</p>	<p>OFF</p> <p>0.1 - 9.9</p>	Seconds
FAC	<p>Factory setting (FACtory)</p> <p>This can be used to reset the device to its factory settings</p> <ul style="list-style-type: none"> - cancel reset - reset the parameters for the selected welding process to their factory settings - reset the parameters for all welding processes to their factory settings <p> Resetting of the selected value to its factory setting must be confirmed by pressing the adjusting dial.</p>	<p>no</p> <p>YES</p> <p>ALL</p>	
2nd	<p>Level 2 Setup menu</p> <p>To set general welding parameters</p> <p>For details, see the "Level 2 Setup menu" chapter</p>		

Setup menu - Level 2

Welding parameters in the level 2 Setup menu

Parameter	Description	Range	Unit
50F	<p>Software version</p> <p>The full version number of the currently installed software is spread across a number of displays and can be retrieved by turning the adjusting dial.</p>		
t5d	<p>Automatic switch-off (time Shut down)</p> <p>If the device is not used or operated for a specified period of time, it automatically switches itself into Standby mode</p> <p>Pressing any button on the control panel will cancel Standby mode and the device will be ready to resume welding</p> <p>Factory setting: OFF</p>	5 - 60 OFF	Minutes
FUS	<p>Fuse</p> <p>For displaying/setting the fuse used</p> <p>Factory setting:</p> <ul style="list-style-type: none"> - for mains voltage 230 V = 16 A - for mains voltage 120 V = 20 A <p>If a fuse is set on the welding system, the welding system limits the power drawn from the mains. This prevents the automatic circuit breaker from tripping immediately</p>	<p>At</p> <p>230 V: 10 / 13 / 16 / OFF (TP 180 MV only)</p> <p>At</p> <p>120 V: 15 / 16 / 20 / OFF (TP 180 MV only)</p>	Ampere

Ignis 150 - Ratio between set fuse and welding current:				
Mains voltage	Set fuse	Welding current electrode	TIG welding current	Duty cycle
230 V	10 A	110 A	150 A	35%
	13 A	130 A	150 A	35%
	16 A	150 A	150 A	35%

Ignis 180 - Ratio between set fuse and welding current:				
Mains voltage	Set fuse	Welding current electrode	TIG welding current	Duty cycle
230 V	10 A	125 A	180 A	40%
	13 A	150 A	200 A	40%
	16 A	180 A	220 A	40%

	OFF (TP 180 MV only)	180 A	220 A	40%
120 V*	15 A	85 A	130 A	40%
	16 A	95 A	140 A	40%
	20 A (TP 180 MV only)	120 A	170 A	40%
	OFF (TP 180 MV only)	120 A	170 A	40%

* Depending on the triggering characteristic of the automatic circuit breaker, the full duty cycle of 40% cannot be achieved on 120 V grids (e.g. USA circuit breaker type CH-15% D.C.)

Parameter	Description	Range	Unit
Sot	<p>Operating time (System on time)</p> <p>For displaying the operating time (begins to count as soon as the device is switched on)</p> <p>The full operating time is spread across a number of displays and can be retrieved by turning the adjusting dial</p>		Hours, minutes, seconds
SAt	<p>Welding time (System Active time)</p> <p>For displaying how long the system has been active for (only shows the time during which welding was in progress)</p> <p>The full system active time is spread across a number of displays and can be retrieved by turning the adjusting dial</p>		Hours, minutes, seconds

Care, maintenance and disposal

Safety

WARNING!

Danger from incorrect operation and work that is not carried out properly.

This can result in serious personal injury and damage to property.

- ▶ All the work and functions described in this document must only be carried out by technically trained and qualified personnel.
 - ▶ Read and understand this document in full.
 - ▶ Read and understand all safety rules and user documentation for this device and all system components.
-

WARNING!

Danger from electric current.

This can result in serious personal injury and damage to property.

- ▶ Before starting work, switch off all the devices and components involved and disconnect them from the grid.
 - ▶ Secure all the devices and components involved to prevent unintentional re-starting.
 - ▶ After opening the device, use a suitable measuring instrument to check that electrically charged components (such as capacitors) have been discharged.
-

WARNING!

Danger due to insufficient ground conductor connection.

This can result in serious personal injury and damage to property.

- ▶ The housing screws provide a suitable ground conductor connection for grounding the housing.
 - ▶ The housing screws must not under any circumstances be replaced by other screws without a reliable ground conductor connection.
-

General

Under normal operating conditions, the device requires only a minimum of care and maintenance. However, it is vital to observe some important points to ensure the device remains in a usable condition for many years.

Maintenance at every start-up

- Ensure that the mains plug and mains cable as well as the welding torch / electrode holder are undamaged. Replace any damaged components.
- Make sure that the welding torch / electrode holder and the grounding cable are properly connected to the welding system and screwed / locked as described in this document
- Ensure that a proper ground earth connection has been established to the workpiece.
- Check that there is an all-round clearance of 0.5 m (1 ft 8 in.) around the device to ensure that cooling air can flow in and out freely. Air inlets and outlets must never be covered, not even partially.

**Maintenance
every 2 months**

Clean air filter:

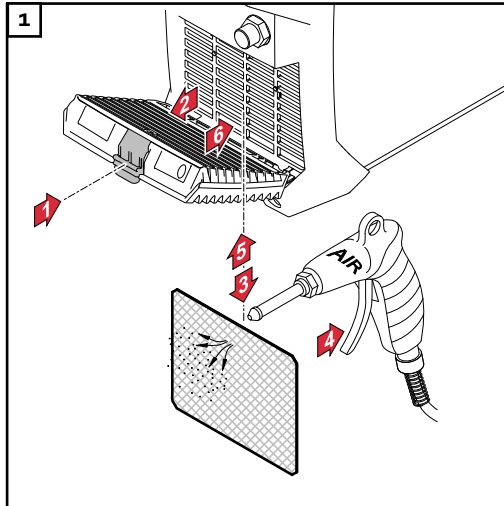

Disposal

Dispose of in accordance with the applicable national and local regulations.

Troubleshooting

Safety

WARNING!

Danger from incorrect operation and work that is not carried out properly.

This can result in serious personal injury and damage to property.

- ▶ All the work and functions described in this document must only be carried out by technically trained and qualified personnel.
 - ▶ Read and understand this document in full.
 - ▶ Read and understand all safety rules and user documentation for this device and all system components.
-

WARNING!

Danger from electric current.

This can result in serious personal injury and damage to property.

- ▶ Before starting work, switch off all the devices and components involved and disconnect them from the grid.
 - ▶ Secure all the devices and components involved to prevent unintentional re-starting.
 - ▶ After opening the device, use a suitable measuring instrument to check that electrically charged components (such as capacitors) have been discharged.
-

WARNING!

Danger due to insufficient ground conductor connection.

This can result in serious personal injury and damage to property.

- ▶ The housing screws provide a suitable ground conductor connection for grounding the housing.
 - ▶ The housing screws must not under any circumstances be replaced by other screws without a reliable ground conductor connection.
-

Indicated errors

Overtemperature

"hot" appears on the display, the temperature indicator lights up



Cause: Operating temperature too high

Remedy: Allow device to cool (do not switch off the device - the fan will cool it down)

Service messages

When E and a 2-digit error number appear on the display (e.g. E02) and the 'Error' indicator lights up, this is an internal welding system source service code.

Example:



It is also possible that several error numbers are present. These appear when turning the adjusting dial.



Make a note of the error numbers shown on the display, and of the serial number and configuration of the welding system, and contact our after-sales service team with a detailed description of the error.

E01 - E03 / E11 / E15 / E21 / E33 - E35 / E37 - E40 / E42 - E44 / E46 - E52

Cause: Fault in power module
Remedy: Contact After-Sales Service

E04

Cause: Open circuit voltage is not being reached:
electrode in contact with workpiece / hardware fault
Remedy: Remove electrode holder from workpiece. If the service code continues to be displayed, contact after-sales service

E05 / E06 / E12

Cause: System start-up failed
Remedy: Switch device off and on again. Contact after-sales service if a repeated occurrence

E10

Cause: Overvoltage at the current socket ($> 113 V_{DC}$)
Remedy: Contact after-sales service

E16 / E17

Cause: Memory fault
Remedy: Contact After-Sales Service / Press adjusting dial to acknowledge the service message

NOTE!

On standard variants of the device, acknowledging the service message has no effect on the availability of welding system functions.

On all other variants (TIG, etc.), only a restricted range of functions is available after acknowledging the message. Contact After-Sales Service to have the full functionality restored.

E19

Cause: Overtemperature or undertemperature
Remedy: Operate the device in permitted ambient temperatures. For more details on environmental conditions, see "Environmental conditions" in the "Safety rules" section

E20

Cause: Improper use of the device
Remedy: Only use the device for its intended purpose

E22

Cause: Welding current set too high
Remedy: Ensure that the welding system is being operated on the correct mains voltage; ensure that the correct fuse is set; set a lower welding current

E37

Cause: Mains voltage too high

Remedy: Pull out the mains plug immediately; ensure that the welding system is being operated on the correct mains voltage

E36, E41, E45

Cause: Mains voltage outside tolerance or maximum load of grid is too low

Remedy: Ensure that the welding system is being operated on the correct mains voltage; ensure that the correct fuse is set;

E65 - E75

Cause: Communication error with the display

Remedy: Switch device off and on again / contact after-sales service if a repeated occurrence

No function

The device cannot be switched on

Cause: Mains switch is faulty

Remedy: Contact After-Sales Service

No welding current

Welding system is switched on, indicator for the selected welding process is lit

Cause: Welding power-lead connections have been disconnected

Remedy: Establish proper welding power-lead connections

Cause: Poor or no earth

Remedy: Establish a connection to the workpiece

Cause: There is a break in the power cable in the welding torch or electrode holder

Remedy: Replace welding torch or electrode holder

No welding current

Device switched on, indicator for the selected welding process is lit, overtemperature indicator lit

Cause: Duty cycle exceeded - device overloaded - fan running

Remedy: Keep within duty cycle

Cause: Thermostatic automatic circuit breaker has switched off the device

Remedy: Wait until the welding system comes back on automatically at the end of the cooling phase (do not switch off the device - the fan will cool it down)

Cause: Faulty fan in welding system

Remedy: Contact After-Sales Service

Cause: Insufficient cooling air intake

Remedy: Ensure adequate air supply

Cause: Air filter is dirty

Remedy: clean air filter

Cause: Power module error

Remedy: Turn off the device, then turn it on again.

If the error occurs frequently, contact After-Sales Service.

Faulty operation

Poor ignition properties during MMA welding

Cause: Incorrect welding process selected

Remedy: Select "MMA welding" or "MMA welding with Cel electrode" process

Cause: Starting current too low; electrode sticking during ignition

Remedy: Increase starting current using HotStart function

Cause: Starting current too high; electrode consumed too quickly during ignition or is generating a lot of spatter

Remedy: Reduce starting current using SoftStart function

In some cases, arc breaks during welding

Cause: Break voltage (Uco) set too low

Remedy: Increase break voltage (Uco) in Setup menu

Cause: Electrode (e.g. grooved electrode) voltage too high

Remedy: If possible, use an alternative electrode or a power source with more welding power

Rod electrode tends to stick

Cause: Value of arc-force dynamic parameter (MMA welding) set too low

Remedy: Increase value of arc-force dynamic parameter

Poor weld properties

(severe spattering)

Cause: Incorrect electrode polarity

Remedy: Reverse electrode polarity (refer to manufacturer's instructions)

Cause: Poor grounding (earthing) connection

Remedy: Fasten earthing clamps directly to workpiece

Cause: Setup parameters not ideal for selected welding process

Remedy: Select the optimal settings in the Setup menu for the selected welding process

Tungsten electrode melting

Tungsten inclusions in base metal during the ignition phase

Cause: Incorrect tungsten electrode polarity

Remedy: Connect the TIG welding torch to the (-) current socket

Cause: Incorrect (or no) shielding gas

Remedy: Use inert shielding gas (argon)

Average consumption values during welding

Average wire electrode consumption during MIG/MAG welding

Average wire electrode consumption at a wire speed of 5 m/min			
	1.0 mm wire electrode diameter	1.2 mm wire electrode diameter	1.6 mm wire electrode diameter
Steel wire electrode	1.8 kg/h	2.7 kg/h	4.7 kg/h
Aluminium wire electrode	0.6 kg/h	0.9 kg/h	1.6 kg/h
CrNi wire electrode	1.9 kg/h	2.8 kg/h	4.8 kg/h

Average wire electrode consumption at a wire speed of 10 m/min			
	1.0 mm wire electrode diameter	1.2 mm wire electrode diameter	1.6 mm wire electrode diameter
Steel wire electrode	3.7 kg/h	5.3 kg/h	9.5 kg/h
Aluminium wire electrode	1.3 kg/h	1.8 kg/h	3.2 kg/h
CrNi wire electrode	3.8 kg/h	5.4 kg/h	9.6 kg/h

Average shielding gas consumption during MIG/MAG welding

Wire electrode diameter	1.0 mm	1.2 mm	1.6 mm	2.0 mm	2 x 1.2 mm (TWIN)
Average consumption	10 l/min	12 l/min	16 l/min	20 l/min	24 l/min

Average shielding gas consumption during TIG welding

Gas nozzle size	4	5	6	7	8	10
Average consumption	6 l/min	8 l/min	10 l/min	12 l/min	12 l/min	15 l/min

Technical data

Explanation of the term "duty cycle"

Duty cycle (ED) is the proportion of time in a 10-minute cycle at which the device may be operated at its rated output without overheating.

NOTE!

The ED values specified on the rating plate are based on an ambient temperature of 40 °C.

If the ambient temperature is higher, either the ED or output must be reduced accordingly.

Example: Welding at 150 A at 60% ED

- Welding phase = 60% of 10 minutes = 6 minutes
- Cooling phase = remaining time = 4 minutes
- After the cooling phase, the cycle begins again.

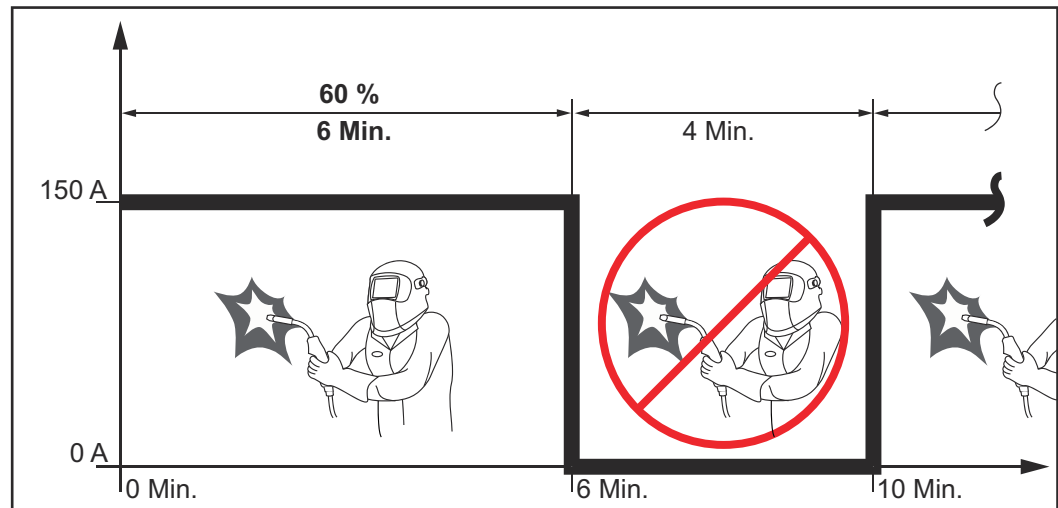

If the device is to be continuously operated without stopping:

- 1 Look in the technical data for a ED value of 100% for the current ambient temperature.
- 2 Reduce the output or amperage in line with this value so that the device can remain in use without observing a cooling phase.

Ignis 150 TIG

Mains voltage (U_1)	1 x 230 V
Max. effective primary current ($I_{1\text{eff}}$)	15 A
Max. primary current ($I_{1\text{max}}$)	24 A
Max. apparent power ($S_{1\text{max}}$)	5.52 kVA
Mains fuse	16 A slow-blow
Mains voltage tolerance	-20% / +15%
Grid frequency	50/60 Hz

Cos phi	0.99		
Max. permitted mains impedance Z_{\max} at PCC ¹⁾	32 mOhm		
Recommended residual current circuit breaker	Type B		
Welding current range (I_2) rod electrode	10-150 A		
Welding current range (I_2) TIG	10-150 A		
Welding current for MMA welding 10 min / 40 °C (104 °F)	35 % 150 A	60 % 110 A	100 % 90 A
Welding current for TIG welding 10 min / 40°C (104°F)	35 % 150 A	60 % 110 A	100 % 90 A
Output voltage range according to standard characteristic (U_2) rod electrode	20.4-26 V		
Output voltage range according to standard characteristic (U_2) TIG	10.4-16 V		
Open circuit voltage (U_0 peak)	96 V		
Protection class	IP 23		
Type of cooling	AF		
Overvoltage category	III		
Pollution degree according to IEC60664	3		
EMC emission class	A		
Safety symbols	S, CE		
Max. shielding gas pressure	5 bar 72.52 psi		
Dimensions (length x width x height)	365 x 130 x 285 mm 14.4 x 5.1 x 11.2 in.		
Weight	6.6 kg 14.6 lb.		
Idle state power consumption at 230 V	15 W		
Energy efficiency of the welding system at 150 A / 26 V	87%		

1) Interface to a 230/400 V and 50 Hz public grid

Ignis 180 TIG

Mains voltage (U_1)	1 x 230 V
Max. effective primary current ($I_{1\text{eff}}$)	16 A
Max. primary current ($I_{1\text{max}}$)	25 A
Max. apparent power ($S_{1\text{max}}$)	5.75 kVA
Mains fuse	16 A slow-blow

Mains voltage tolerance	-20% / +15%		
Grid frequency	50/60 Hz		
Cos phi	0.99		
Max. permitted mains impedance Z_{max} at PCC ¹⁾	285 mOhm		
Recommended residual current circuit breaker	Type B		
Welding current range (I_2) rod electrode	10-180 A		
Welding current range (I_2) TIG	10-220 A		
Welding current for MMA welding 10 min / 40 °C (104 °F)	40 % 180 A	60 % 150 A	100 % 120 A
Welding current for TIG welding 10 min / 40°C (104°F)	40 % 220 A	60 % 150 A	100 % 120 A
Output voltage range according to standard characteristic (U_2) rod electrode	20.4-27.2 V		
Output voltage range according to standard characteristic (U_2) TIG	10.4-18.8 V		
Open circuit voltage (U_0 peak)	101 V		
Protection class	IP 23		
Type of cooling	AF		
Overvoltage category	III		
Pollution degree according to IEC60664	3		
EMC emission class	A		
Safety symbols	S, CE		
Max. shielding gas pressure	5 bar 72.52 psi		
Dimensions (length x width x height)	435 x 160 x 310 mm 17.1 x 6.3 x 12.2 in.		
Weight	9.0 kg 19.8 lb.		
Idle state power consumption at 230 V	15 W		
Welding system energy efficiency at 180 A/27.2 V	88%		

1) Interface to a 230/400 V and 50 Hz public grid

Ignis 180 TIG MV

Mains voltage (U_1)	1 x 230 V	1 x 120 V	1 x 120 V
-------------------------	-----------	-----------	-----------

Max. effective primary current ($I_{1\text{eff}}$)	16 A	20 A	15 A
Max. primary current ($I_{1\text{max}}$)	25 A	29 A	19 A
Max. apparent power ($S_{1\text{max}}$)	5.75 kVA	3.48 kVA	2.28 kVA
Mains fuse	16 A slow-blow	20 A slow-blow	15 A slow-blow
Mains voltage tolerance	-20% / +15%		
Grid frequency	50/60 Hz		
Cos phi	0.99		
Max. permitted mains impedance Z_{max} at PCC ¹⁾	285 mOhm		
Recommended residual current circuit breaker	Type B		
Welding current range (I_2)			
Rod electrode	10 - 180 A	10 - 120 A	10 - 85 A
TIG	10 - 220 A	10 - 170 A	10 - 140 A
Welding current for MMA welding, 10 min / 40 °C (104 °F)	40%/180 A 60%/150 A 100%/120 A	40%/120 A 60%/100 A 100%/90 A	40%/85 A 60%/70 A 100%/65 A
Welding current for TIG welding, 10 min / 40°C (104°F)	40%/220 A 60%/160 A 100%/130 A	40%/170 A 60%/130 A 100%/100 A	40%/140 A 60%/110 A 100%/100 A
Output voltage range according to standard characteristic (U_2)			
Rod electrode	20.4 - 27.2 V		
TIG	10.4 - 18.8 V		
Open circuit voltage (U_0 peak)	101 V		
Protection class	IP 23		
Type of cooling	AF		
Oversvoltage category	III		
Pollution degree according to IEC60664	3		
EMC emission class	A		
Safety symbols	S, CE		
Max. shielding gas pressure	5 bar 72.52 psi		
Dimensions (length x width x height)	435 x 160 x 310 mm 17.1 x 6.3 x 12.2 in.		
Weight	9.2 kg 20.3 lb.		
Idle state power consumption at 230 V	15 W		
Welding system energy efficiency at 180 A/27.2 V	88%		

1) Interface to a 230/400 V and 50 Hz public grid

Overview with critical raw materials, year of production of the device

Overview with critical raw materials:

An overview of which critical raw materials are contained in this device can be found at the following Internet address.

www.fronius.com/en/about-fronius/sustainability.

To calculate the year of production of the device:

- Each device is provided with a serial number
- The serial number consists of 8 digits - for example 28020099
- The first two digits give the number from which the year of production of the device can be calculated
- This figure minus 11 gives the year of production
 - For example: Serial number = 28020065, calculation of the year of production = 28 - 11 = 17, year of production = 2017



Fronius International GmbH

Froniusstraße 1
4643 Pettenbach
Austria
contact@fronius.com
www.fronius.com

At www.fronius.com/contact you will find the contact details
of all Fronius subsidiaries and Sales & Service Partners.